

SYSTEM OVERVIEW

Description: -48 VDC @ 200A / +24 VDC @ 50A Power System
(System with List 7 Distribution Cabinet)

Vertiv cabinets F2012504, F2015053, and F2016064:
-48 VDC @ 525A / +24 VDC @ 400A (400A per row)
(System with List 27 Distribution Cabinet)

Vertiv cabinet F2021019:
-48 VDC @ 525A / -58 VDC (max.) @ 274A (max.)
(400A per row for the -48 VDC and 274A per row for the -58 VDC)
(System with List 27 Distribution Cabinet)

Vertiv cabinets F2020029, F2020030:
-48 VDC @ 525A / -58 VDC (max.) @ 300A (max.)
(400A per row for the -48 VDC and 300A per row for the -58 VDC)
(System with List 27 Distribution Cabinet)

Non-Vertiv cabinet system:
Power system tested in 65° C ambient without airflow:
-48 VDC @ 400A / -58 VDC (max.) @ 300A (max.)
(300A per row for both -48 VDC and -58 VDC.)
(System with List 27 Distribution Cabinet)

The Vertiv™ NetSure™ 512NGBB DC Power System is an integrated power system containing rectifiers, optional converters, intelligent control, metering, monitoring, and distribution. A power system with List 27 distribution cabinet is usually a part of a configured cabinet system. However, there is a stand-alone model available which is tested in a 65°C ambient. It does not fit into a standard relay rack but can be mounted in non-Vertiv cabinets. A power system with List 7 distribution cabinet can be ordered as part of a configured system to be mounted into an equipment cabinet designed for the power system or as a stand-alone system to be mounted in a relay rack.

This power system is designed to power a load while charging a positive grounded battery. This power system is capable of operating in a batteryless installation or off battery for maintenance purposes. The power system is designed for operation with the positive output grounded.

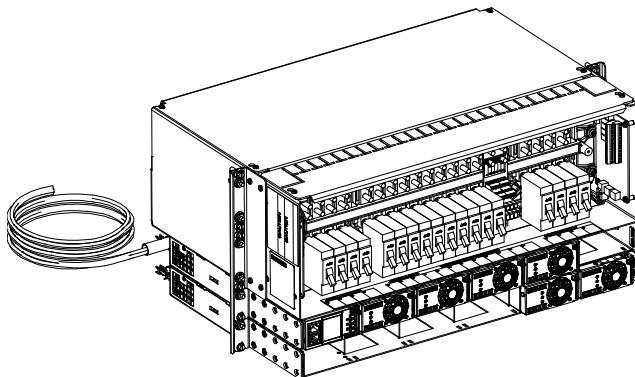

System with List 7 Distribution Cabinet

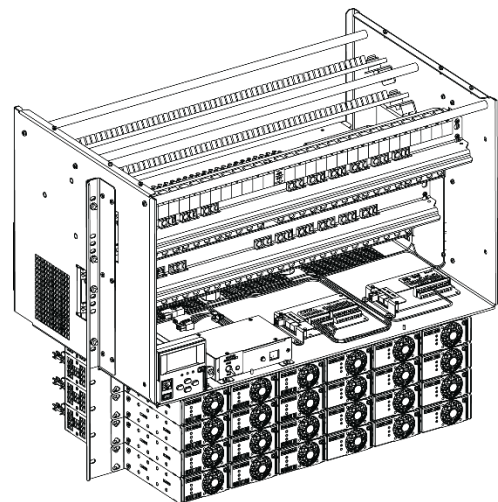

System with List 27 Distribution Cabinet

This system consists of the following components.

- **Distribution Cabinet**

The system always includes a distribution cabinet, which provides DC distribution through fuses and/or circuit breakers. The distribution cabinet may house the controller (depending on system configuration).

List 7: The List 7 distribution cabinet accepts one (1) distribution panel (List BW). List BW distribution panel provides dual voltage load distribution (-48 VDC primary voltage and +24 VDC secondary voltage) and -48 VDC battery disconnect positions. This distribution panel is configured to accept bullet nose type circuit breakers and TPS/TLS fuseholders.

List 27: The List 27 distribution cabinet accepts two (2) distribution panels. A variety of distribution panels are available that provide load distribution and dual voltage load distribution for use with +24 VDC converters or -58 VDC converters. These distribution panels are configured to accept bullet nose type circuit breakers and TPS/TLS fuseholders.

The distribution cabinet may be equipped with low voltage load disconnect (LVLD), low voltage battery disconnect (LVBD), and in a List 27 a manual battery disconnect (depending on available configuration options).

- **Controller**

The controller controls the operation of the rectifier and converter modules. The controller also provides power system control, metering, monitoring, and alarm functions.

NCU (NetSure Control Unit): The controller provides power system control (including optional low voltage battery disconnect (LVBD) and low voltage load disconnect (LVLD) control), rectifier control (including a charge control function), converter control, metering functions, monitoring functions, local/remote alarm functions, and connections for binary inputs and programmable relay outputs. The controller also supports rectifier temperature compensation if the system is equipped with a temperature probe(s). Temperature probe(s) may also be designated to monitor ambient temperature and/or battery temperature. The controller also provides data acquisition, system alarm management, and advanced battery and energy management. The controller contains a color TFT display and keypad for local access. The controller provides an Ethernet port and comes with comprehensive webpages for remote access. The controller has SNMP V3 capability for remote system management. The controller supports software upgrade via its USB port. Refer to the NCU Controller Instructions (UM1M830BNA) for more information.

- **Module Mounting Shelf**

The system contains one (1) to four (4) module mounting shelves (depending on system configuration, see “List Descriptions” starting on page 9), which may house rectifier modules, optional converter modules, and a controller (depending on shelf configuration, see “List Descriptions” in Power Data Sheet PD588705300). Refer to PD588705300 for additional information.

- **Rectifier Modules**

The system contains rectifier modules, which provide load power, battery float current, and battery recharge current during normal operating conditions. Refer to the Rectifier Instructions (UM1R482000E3) for more information.

- **Optional -48 VDC to +24 VDC Converter Modules**

Where +24 VDC load power is also required, DC-DC converter modules are available. These converters operate from the main -48 VDC system bus to provide +24 VDC load power. Refer to the Converter Instructions (UM1C48241500) for more information.

- **Optional -48 VDC to -58 VDC Converter Modules**

Where -58 VDC load power is also required, converter modules are available (depending on configuration, see “List Descriptions” starting on page 9). These converters operate from the main -48 VDC system bus to provide -58 VDC load power. Refer to the Converter Instructions (UM1C48582000P3) for more information.

Vertiv™ NetSure™ 512NGBB DC Power System

System Application Guide

General Specifications

See detailed specifications starting on page 64.

Family:	NetSure
System Spec. No.:	582137000
System Model:	512NGBB
System AC Input Voltage	Nominal 120/208/240 volts AC, single phase, 3-wire, 50/60 Hz, with an operating range of 85 to 290 volts AC. Acceptable input frequency range is 45 to 65 Hz.
System DC Output Capacity:	
System:	200A @ -48 VDC and 50A @ +24 VDC (System with List 7 Distribution Cabinet) Vertiv cabinets F2012504, F2015053, and F2016064: <u>525A @ -48 VDC and 400A @ +24 VDC (400A per row)</u> (System with List 27 Distribution Cabinet) Vertiv cabinet F2021019: <u>525A @ -48 VDC and 274A (max.) @ -58 VDC (max.)</u> (400A per row for the -48 VDC and 274A per row for the -58VDC) (System with List 27 Distribution Cabinet) Vertiv cabinets F2020029, F2020030: <u>525A @ -48 VDC and 300A (max.) @ -58 VDC (max.)</u> (400A per row for the -48 VDC and 300A per row for the -58VDC) (System with List 27 Distribution Cabinet) Non-Vertiv cabinet system: Power system tested in 65° C ambient without airflow: <u>400A @ -48 VDC and 300A (max.) @ -58 VDC (max.)</u> (300A per row for both -48 VDC and -58 VDC.) (System with List 27 Distribution Cabinet)
Distribution Panel:	200A, maximum (List 7 Distribution Cabinet) 400A, maximum (List 27 Distribution Cabinet) 300A, maximum, -58 VDC maximum (List 27 Distribution Cabinet)
588705300 Shelf Ratings:	See PD588705300.
1R482000E3 Rectifier Rating:	See UM1R482000E3.
1C48241500 Converter Rating:	See UM1C48241500.
1C48582000P3 Converter Rating:	See UM1C48582000P3.
System Agency Approval:	UL 1801 Recognized ("c UR") , NEBS
Framework Type:	Rack Mounted in a Cabinet
Mounting Width:	See "Mechanical Specifications" starting on page 66.
Mounting Depth:	See "Mechanical Specifications" starting on page 66.
Access:	Front for Operation Front and Rear for Installation and Maintenance
Supplemental Bay(s) Available:	None
Control:	Microprocessor
Color:	Bay and Module Faceplates: Textured Gray Module Mounting Shelf and Module Bodies: Bright Zinc Plating
Environment:	-40°C to +65°C (-40°F to +149°F)

Vertiv™ NetSure™ 512NGBB DC Power System

System Application Guide

TABLE OF CONTENTS

SYSTEM OVERVIEW	1
MAIN COMPONENTS ILLUSTRATIONS.....	7
System with a List 7 Distribution Cabinet.....	7
System with a List 27 Distribution Cabinet.....	8
LIST DESCRIPTIONS	9
List Numbers.....	9
List 7: 1-Row Distribution Cabinet.....	9
List 27: 2-Row Distribution Cabinet	10
List 30: Module Mounting Shelf Interface Components.....	11
List 31: Field Expansion Module Mounting Shelf.....	11
List 70: Optional EIB (Controller Extended Interface Board), P/N 548120	12
List 500: -48 VDC/-58 VDC Power System	12
List 501: -48 VDC/-58 VDC Power System.....	13
Single Voltage Load Distribution Panel.....	15
List AC: -48 VDC Load Distribution Panel (30) -48 VDC Bullet/TPS/TLS Circuit Breaker/Fuse Load Positions.....	15
Dual Voltage Plus Battery Disconnect Distribution Panel.....	16
List BW: -48V / +24 VDC Load Distribution Plus -48 VDC Battery Disconnect Panel (12) -48 VDC Bullet/TPS/TLS Circuit Breaker/Fuse Load Positions (4) +24 VDC Bullet/TPS/TLS Circuit Breaker/Fuse Load Positions (4) -48 VDC Bullet/TPS/TLS Circuit Breaker/Fuse Battery Positions.....	16
Dual Voltage Load Distribution Panel	17
List DH: -48V / +24 VDC Load Distribution Panel (21) -48 VDC Bullet/TPS/TLS Circuit Breaker/Fuse Load Positions (8) +24 VDC Bullet/TPS/TLS Circuit Breaker/Fuse Load Positions	17
List DI: -48V / +24 VDC Load Distribution Panel (17) -48 VDC Bullet/TPS/TLS Circuit Breaker/Fuse Load Positions (12) +24 VDC Bullet/TPS/TLS Circuit Breaker/Fuse Load Positions.....	18
List DJ: -48V / +24 VDC Load Distribution Panel (13) -48 VDC Bullet/TPS/TLS Circuit Breaker/Fuse Load Positions (16) +24 VDC Bullet/TPS/TLS Circuit Breaker/Fuse Load Positions	19
List DK: -48V / +24 VDC Load Distribution Panel (9) -48 VDC Bullet/TPS/TLS Circuit Breaker/Fuse Load Positions (20) +24 VDC Bullet/TPS/TLS Circuit Breaker/Fuse Load Positions	20
List DL: -48V / +24 VDC Load Distribution Panel (5) -48 VDC Bullet/TPS/TLS Circuit Breaker/Fuse Load Positions (24) +24 VDC Bullet/TPS/TLS Circuit Breaker/Fuse Load Positions	21
List FG: -48V / -58 VDC Load Distribution Panel (25) -48 VDC Bullet/TPS/TLS Circuit Breaker/Fuse Load Positions (4) -58 VDC Bullet/TPS/TLS Circuit Breaker/Fuse Load Positions.....	22
List FH: -48V / -58 VDC Load Distribution Panel (21) -48 VDC Bullet/TPS/TLS Circuit Breaker/Fuse Load Positions (8) -58 VDC Bullet/TPS/TLS Circuit Breaker/Fuse Load Positions.....	23
List FI: -48V / -58 VDC Load Distribution Panel (17) -48 VDC Bullet/TPS/TLS Circuit Breaker/Fuse Load Positions (12) -58 VDC Bullet/TPS/TLS Circuit Breaker/Fuse Load Positions	24
List FJ: -48V / -58 VDC Load Distribution Panel (13) -48 VDC Bullet/TPS/TLS Circuit Breaker/Fuse Load Positions (16) -58 VDC Bullet/TPS/TLS Circuit Breaker/Fuse Load Positions.....	25
List FK: -48V / -58 VDC Load Distribution Panel (9) -48 VDC Bullet/TPS/TLS Circuit Breaker/Fuse Load Positions (20) -58 VDC Bullet/TPS/TLS Circuit Breaker/Fuse Load Positions.....	26
List FL: -48V / -58 VDC Load Distribution Panel (5) -48 VDC Bullet/TPS/TLS Circuit Breaker/Fuse Load Positions (24) -58 VDC Bullet/TPS/TLS Circuit Breaker/Fuse Load Positions	27
List FM: -58 VDC Load Distribution Panel (29) -58 VDC Bullet/TPS/TLS Circuit Breaker/Fuse Load Positions	28
List GC: -58 VDC Load Distribution Panel (30) -58 VDC Bullet/TPS/TLS Circuit Breaker/Fuse Load Positions	29
Battery Disconnect Contactor	30
List CA: 600A Battery Disconnect Contactor.....	30
Low Voltage Disconnect Options.....	30
List LB: Low Voltage Battery Disconnect (LVBD) Wiring.....	30
List LL: Low Voltage Load Disconnect (LVLD).....	30
Manual Battery Disconnect Option.....	30
List MB: Manual Battery Disconnect.....	30
ACCESSORY DESCRIPTIONS	31
Controller	31
NCU (NetSure Control Unit) Controller, P/N 1M830DNA or 1M830BNA.....	31
Optional Temperature Probes.....	32
Optional SM-Temp Temperature Concentrator, P/N 547490	33

Vertiv™ NetSure™ 512NGBB DC Power System

System Application Guide

Optional List 27 Critical Alarm Indicator, P/N 555877.....	33
Rectifier Module.....	33
Rectifier Module, P/N 1R482000E3.....	33
Converter Module.....	34
-48 VDC to +24 VDC Converter Module, P/N 1C48241500.....	34
-48 VDC to -58 VDC Converter Module, P/N 1C48582000P3.....	34
Optional eSure™ Power Extend Converter.....	34
-48 VDC to -58 VDC Output Converter Upgrade Field Kit, Retrofit kit, P/N 60028248.....	35
-58V, Busbar, Row 1, Field Kit, P/N 60031305.....	35
Distribution Devices.....	35
Bullet Nose Type Circuit Breakers and Bullet Nose Type Fuseholders e/w TPS/TLS Fuses.....	35
Bullet Nose Bypass Busbar, P/N 535015.....	39
Optional Bullet Nose Type 6-Position GMT Distribution Fuse Block, P/N 549017.....	40
Optional Bullet Nose Type 6-Position GMT Distribution Fuse Block, P/N 545333DCP.....	41
GMT Type Load Distribution Fuses.....	42
Transient Voltage Surge Suppressor (TVSS) Device, P/N 122201 (Kit P/N 520401).....	42
Standard Crimp Lugs, Special Application Crimp Lugs, and Busbar Adapter Kits and Hardware Kits.....	43
Standard Crimp Lug Tables.....	43
Special Application Crimp Lug / Strap Combination Table.....	44
Busbar Adapter and Hardware Kits.....	45
AC Input Cable Assemblies.....	46
AC Input Cable Assembly, P/N 535232.....	46
AC Input Cable Assembly, P/N 547898.....	46
AC Input Wiring Kit, P/N 557836.....	46
Generator Input Circuit Breaker Kit P/N 564898.....	47
User Replaceable Alarm, Reference, and Control Fuses.....	48
User Replaceable Components.....	48
RECOMMENDED WIRE SIZES, BRANCH CIRCUIT PROTECTION, CRIMP LUGS, AND WIRING ILLUSTRATIONS.....	49
Relay Rack / Cabinet Frame Grounding Requirements.....	49
Central Office Grounding Connection.....	49
AC Input and AC Input Equipment Grounding Connections to 588705300 Module Mounting Shelf(s).....	49
External Alarm, Reference, Monitoring, and Control Connections.....	49
General.....	49
582137000 List 7 Distribution Cabinet.....	49
582137000 List 27 Distribution Cabinet.....	49
IB2 (Controller Interface Board).....	49
EIB (Controller Extended Interface Board).....	49
Load Distribution Connections.....	55
General.....	55
582137000 List 7 Distribution Cabinet.....	55
582137000 List 27 Distribution Cabinet.....	55
GMT Fuse Block.....	55
Input Battery Connections.....	62
582137000 List 7 Distribution Cabinet.....	62
582137000 List 27 Distribution Cabinet.....	63
SPECIFICATIONS.....	64
1. System.....	64
1.1 DC Output Ratings.....	64
1.2 AC Input Ratings.....	64
1.3 Environmental Ratings.....	64
1.4 Compliance Information.....	65
1.5 IB2 and EIB (Controller Interface Board) Ratings.....	65
2. Module Mounting Shelf.....	65
3. Rectifier.....	65
4. -48 VDC TO +24 VDC Converter.....	65
5. -48 VDC TO -58 VDC Converter.....	65
6. Controller.....	65
MECHANICAL SPECIFICATIONS.....	66

Vertiv™ NetSure™ 512NGBB DC Power System

System Application Guide

Overall Dimensions.....	66
Systems with List 7 Distribution Cabinet.....	66
Systems with List 27 Distribution Cabinet	68
Weights.....	70
RELATED DOCUMENTATION	71

MAIN COMPONENTS ILLUSTRATIONS

System with a List 7 Distribution Cabinet

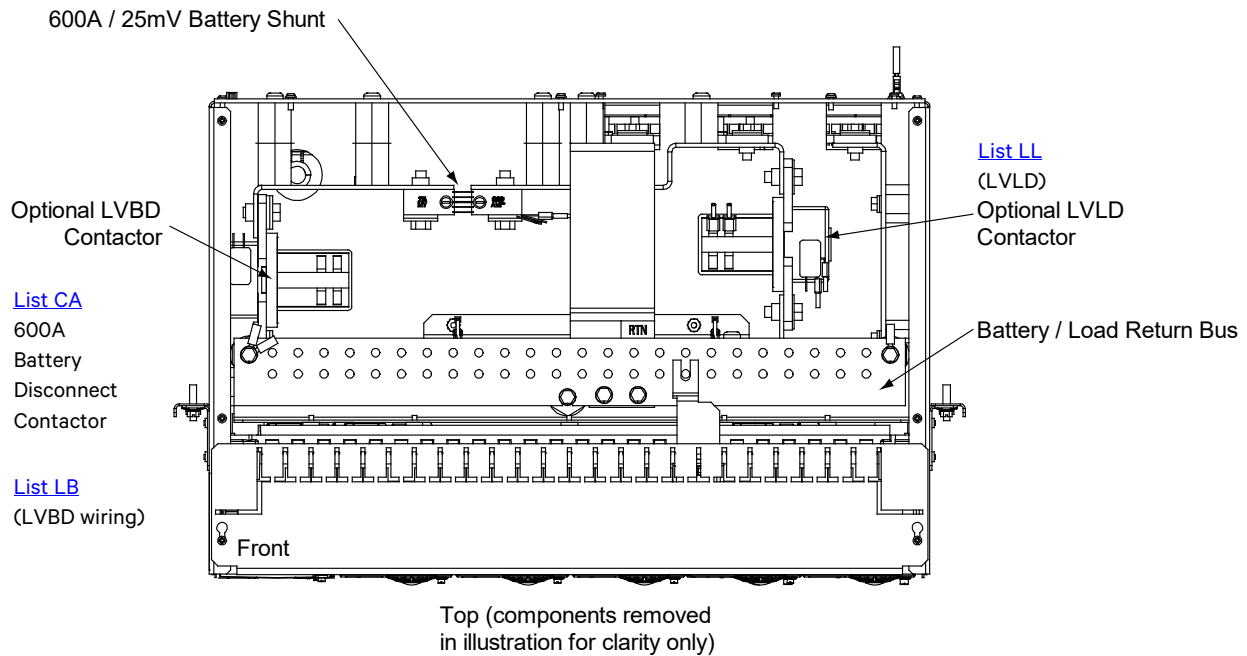
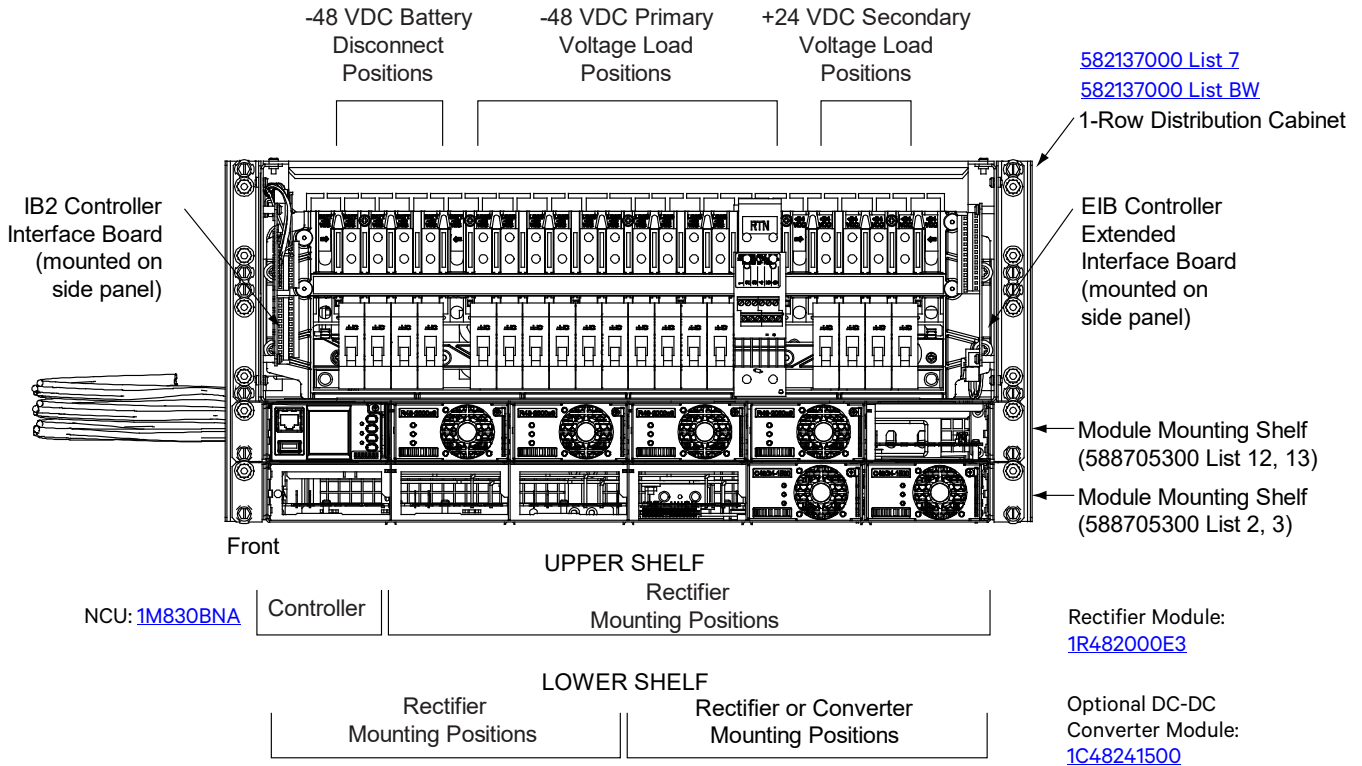

System with a List 27 Distribution Cabinet

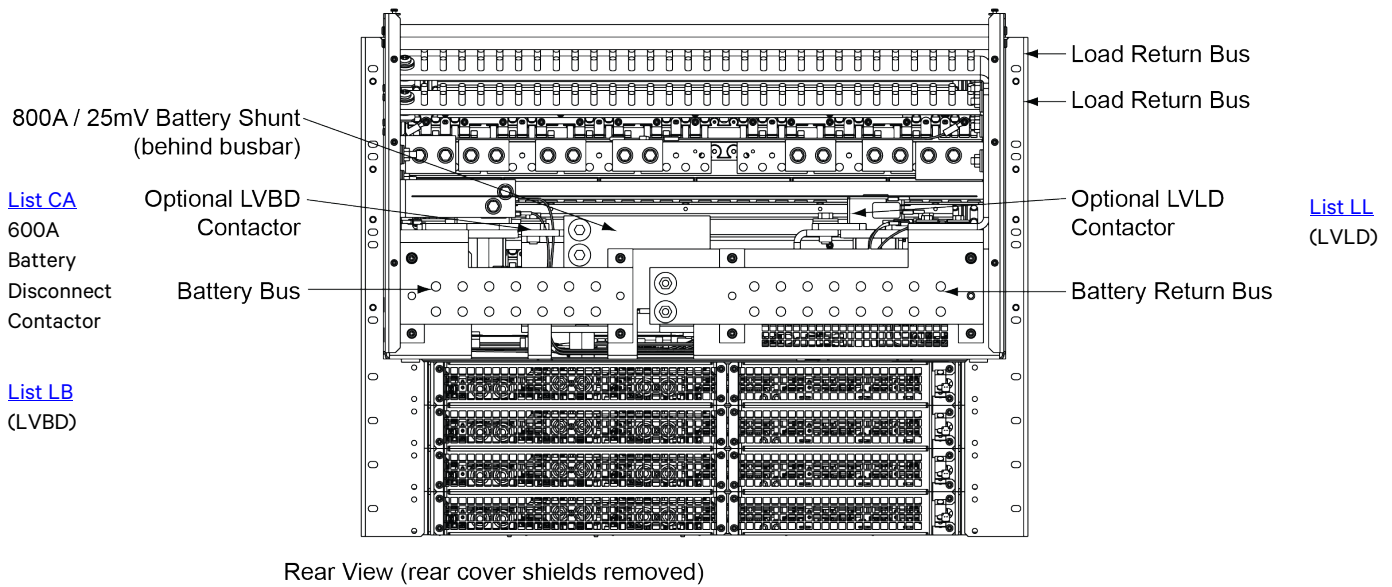
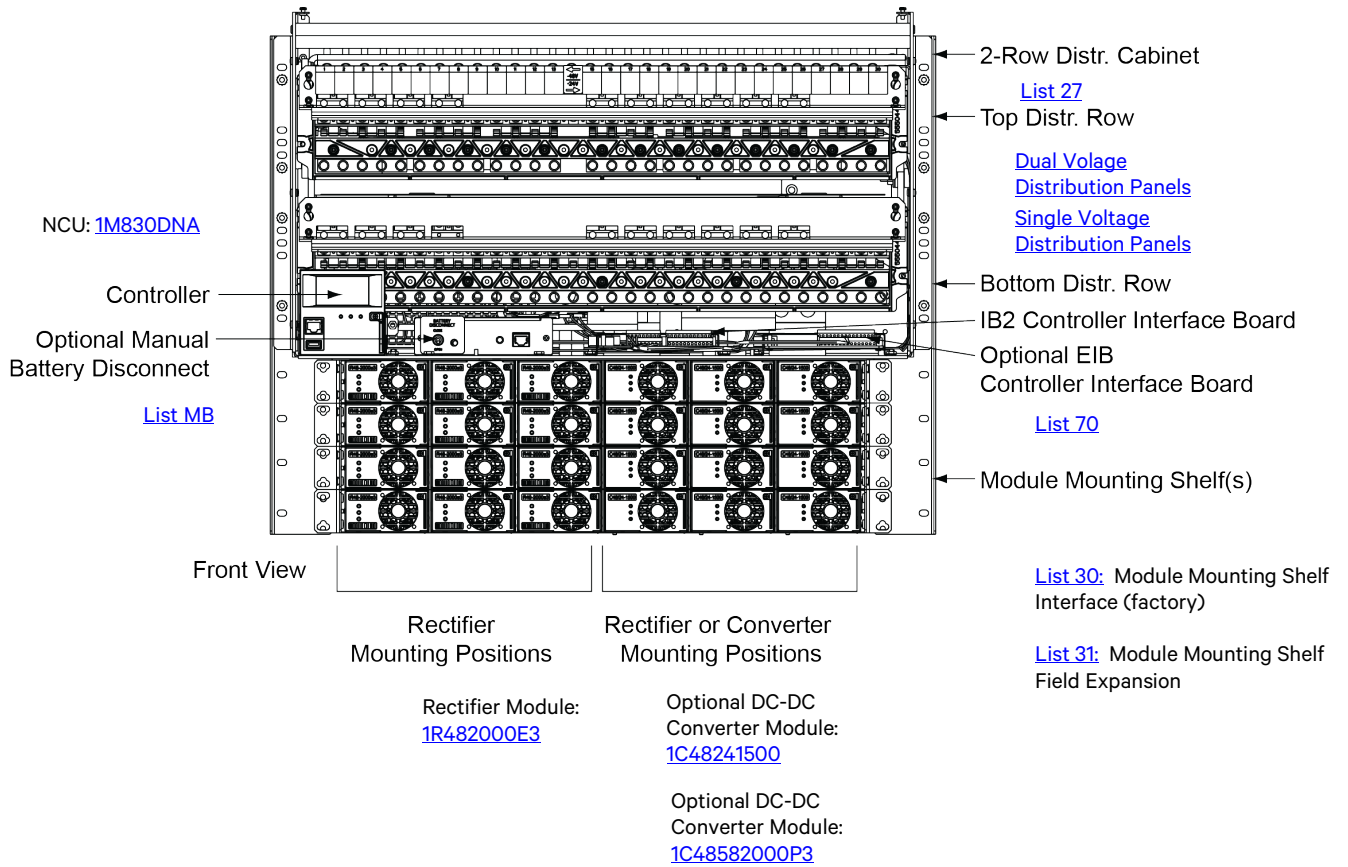

LIST DESCRIPTIONS

List Numbers

List 7: 1-Row Distribution Cabinet

Features

- ◆ 4RU high by 23" wide cabinet.
- ◆ Accepts one (1) distribution panel.
- ◆ Includes the IB2 controller interface board.
- ◆ Includes the EIB controller extended interface board.
- ◆ Rated -48 VDC @ 200A / +24 VDC @ 50A. Maximum power provided by the -48 VDC bus is to be 10920W (-42 VDC @ 260A). The product is rated for a maximum ambient of 65°C.

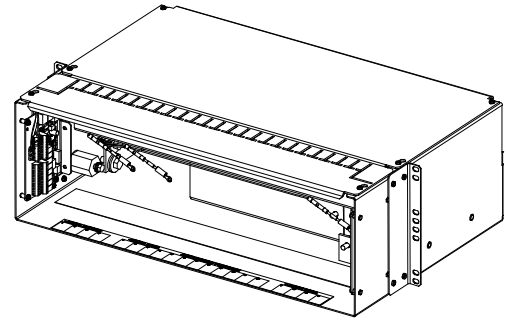

Restrictions

Does not house the controller.

Cannot have [List MB](#).

Only accepts [List BW](#) distribution panel.

Ordering Notes

- 1) Order List 7 and the following for a configured system.
- 2) Order one (1) [List BW](#) distribution panel (see page 16).
- 3) Order fuses and/or circuit breakers as required per “Distribution Devices” on page 35.
- 4) Order P/N [520401](#) TVSS Device Kit(s) as required (see page 42).
- 5) Order P/N [545333DCP](#) 6-position GMT fuse block as required (see on page 41).
Order fuses as required per Table 4.
- 6) Order battery and load distribution lugs, lug adapters, and lug hardware kits as required per “Standard Crimp Lugs, Special Application Crimp Lugs, and Busbar Adapter Kits and Hardware Kits” on page 43.
- 7) Order [List CA](#) battery disconnect contactor, [List LL](#) (specify without busbars) low voltage load disconnect, and [List LB](#) (specify jumper kit P/N 557742) low voltage battery disconnect as required per “Battery Disconnect Contactor” on page 30 and “Low Voltage Disconnect Options” on page 30.
- 8) Order one (1) module mounting shelf 588705300 List 12, 13 per PD588705300 (also order P/N 557836 AC Input Wiring Kit).
 - a) Order P/N [1M830BNA](#) NCU controller.
 - b) Order up to four (4) P/N [1R482000E3](#) rectifier modules, as required.
 - c) Order P/N 557352 rail mounting kit and P/N 557348 output bus kit per [List 30](#) (module mounting shelf interface components) (see page 11).
- 9) Order one (1) module mounting shelf 588705300 List 2, 3 per PD588705300.
 - a) Order up to three (3) P/N [1C48241500](#) DC-DC converter modules, as required.

Vertiv™ NetSure™ 512NGBB DC Power System

System Application Guide

List 27: 2-Row Distribution Cabinet

Features

- ◆ 8RU high by 27" wide cabinet.
- ◆ Accepts up to two (2) distribution panels.
- ◆ Accepts one (1) NCU Controller.
- ◆ Includes the IB2 controller interface board.
- ◆ Accepts the EIB controller extended interface board.
- ◆ Rated -48 VDC @ 525A / +24 VDC @ 400A or -58 VDC (max.) @ 300A (max). 400A maximum per row for the -48 VDC and 300A per row for the -58 VDC. Maximum power provided by the -48 VDC bus is to be 25200W (-42 VDC @ 600A). The product is rated for a maximum ambient of 65°C.

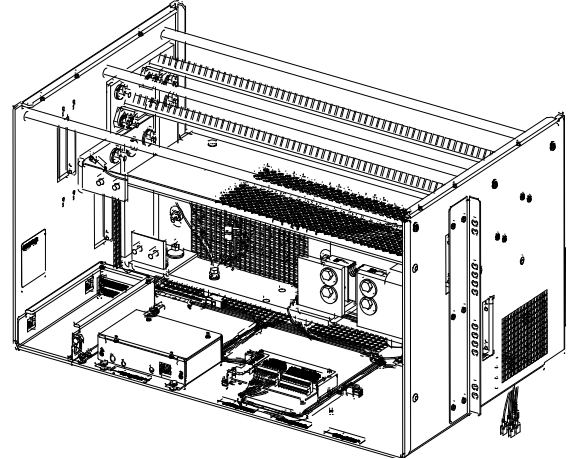

Ordering Notes

- 1) Order List 27 and the following for a configured system.
- 2) Order P/N [1M830DNA](#) NCU controller.
- 3) Order up to two (2) distribution panels as required per “Single Voltage Load Distribution Panel” on page 15 and “Dual Voltage Load Distribution Panel” on page 17.
- 4) Order fuses and/or circuit breakers as required per “Distribution Devices” on page 35.
- 5) Order P/N [520401](#) TVSS Device Kit(s) as required (see page 42).
- 6) Order P/N [549017](#) 6-position GMT fuse block as required (see page 40).
Order fuses as required per Table 4.
- 7) Order battery and load distribution lugs, lug adapters, and lug hardware kits as required per “Standard Crimp Lugs, Special Application Crimp Lugs, and Busbar Adapter Kits and Hardware Kits” on page 43.
- 8) Order [List CA](#) battery disconnect contactor, [List LL](#) low voltage load disconnect, [List LB](#) (specify jumper kit P/N 555855) low voltage battery disconnect, and [List MB](#) manual battery disconnect as required per “Battery Disconnect Contactor” on page 30 and “Low Voltage Disconnect Options” on page 30.
- 9) Order interface components for module mounting shelf(s) as required per [List 30](#) (see page 11). Order up to four (4) module mounting shelf(s) per PD588705300. Order a field expansion module mounting shelf per [List 31](#) (see page 11) (cannot expand system beyond four [4] module mounting shelves).
 - a) Order up to six (6) per shelf P/N [1R482000E3](#) rectifier modules, as required. Cannot exceed six (6) rectifier and converter modules total per shelf.
 - b) Order up to three (3) per shelf P/N [1C48241500](#) DC-DC converter modules, as required. Cannot order P/N [1C48241500](#) DC-DC converter module with the P/N [1C48582000P3](#) DC-DC converter module. Cannot exceed six (6) rectifier and converter modules total per shelf.
 - c) Order up to three (3) per shelf P/N [1C48582000P3](#) DC-DC converter modules, as required. Cannot order P/N [1C48582000P3](#) DC-DC converter module with the P/N [1C48241500](#) DC-DC converter module. Cannot exceed six (6) rectifier and converter modules total per shelf.
- 10) Order optional [List 70](#) EIB controller extended interface board as required (see page 12).

Vertiv™ NetSure™ 512NGBB DC Power System

System Application Guide

List 30: Module Mounting Shelf Interface Components

Features

- ◆ Provides components to add one (1) to four (4) module mounting shelf(s) (Spec. No. 588705300) below the List 27 distribution cabinet.
- ◆ Provides components to add two (2) module mounting shelves (Spec. No. 588705300) below the List 7 distribution cabinet.
- ◆ Each module mounting shelf is 1RU high.

Restrictions

Factory installed only on the distribution cabinet.

Includes 'module mounting shelf-to-power system/distribution cabinet' interconnect components only. The module mounting shelf(s) must be ordered separately.

Use P/N 557352 rail mounting kit and P/N 557348 output bus kit for List 7 only. Use the other kits only on List 27 as required.

Ordering Notes

- 1) Order one (1) List 30 per system. Specify how many module mounting shelf(s) are to be installed in the system with these interconnect components and if the system consists of a List 7 or List 27 distribution cabinet so correct busbars can be provided.

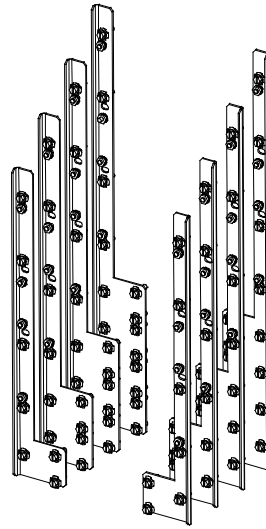

For Use with List 27 Distribution Cabinet:
Four (4) sets of brackets / busbars available to interface with one (1) to four (4) module mounting shelves.

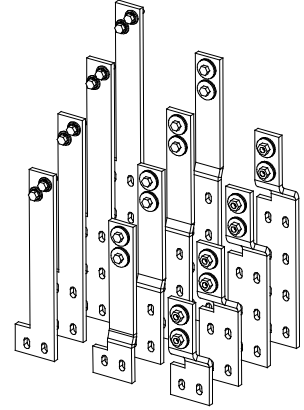

List 31: Field Expansion Module Mounting Shelf

Features

- ◆ Provides a field expansion module mounting shelf.
- ◆ Each module mounting shelf is 1RU high.

Restrictions

Maximum of one (1) List 31 per system.

Cannot expand system beyond four (4) module mounting shelves.

For List 27 only.

Ordering Notes

- 1) Order List 31 for a module mounting shelf to be added in the field.
- 2) Order up to six (6) P/N [1R482000E3](#) rectifier modules, as required. Cannot exceed six (6) rectifier and converter modules total per shelf.
- 3) Order up to three (3) P/N [1C48241500](#) DC-DC converter modules, as required. Cannot order P/N [1C48241500](#) DC-DC converter module with the P/N [1C48582000P3](#) DC-DC converter module. Cannot exceed six (6) rectifier and converter modules total per shelf.
- 4) Order up to three (3) P/N [1C48582000P3](#) DC-DC converter modules, as required. Cannot order P/N [1C48582000P3](#) DC-DC converter module with the P/N [1C48241500](#) DC-DC converter module. Cannot exceed six (6) rectifier and converter modules total per shelf.
- 5) Order mating connectors and cables per "AC Input Cable Assemblies" on page 46.

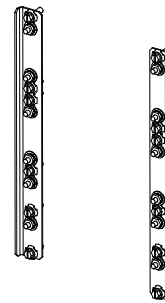

P/N 557352 Rail Mounting Kit

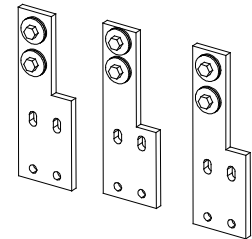

P/N 557348 Output Bus Kit

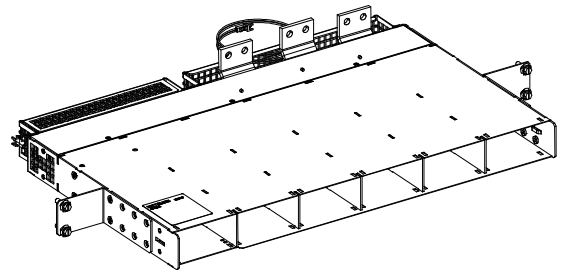

Vertiv™ NetSure™ 512NGBB DC Power System

System Application Guide

List 70: Optional EIB (Controller Extended Interface Board), P/N 548120

Features

- ◆ Installed in a List 27 distribution cabinet.
Note: The EIB (Controller Extended Interface Board) is always factory installed in a List 7 distribution cabinet.
- ◆ The EIB provides five (5) programmable form-C relay outputs, two (2) temperature inputs, three (3) shunt inputs, and eight (8) battery midpoint inputs.
Note: The IB2 (Controller Interface Board) is factory provided with the system. The IB2 provides eight (8) programmable form C-relay outputs, eight (8) programmable binary inputs, and two (2) temperature inputs.

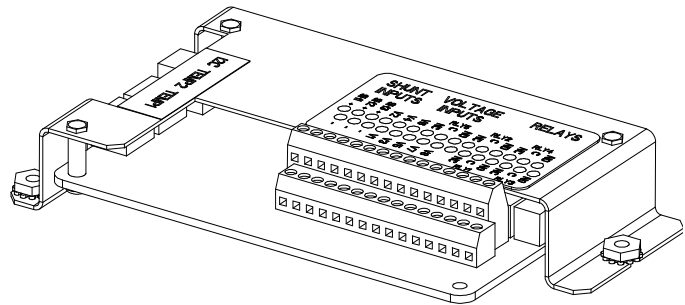

Restrictions

Only one (1) EIB per system.

For List 27 only.

When connecting a shunt to the EIB board, the shunt needs to be installed in the hot (-48V) bus. Connect the plus side of the shunt to the positive shunt input on the EIB. Connect the negative side of the shunt to the negative shunt input on the EIB.

Ordering Notes

- 1) Order one (1) List 70 for a system with a List 27 distribution cabinet, as required.
- 2) Also order up to two (2) additional temperature probes, as desired. See “Optional Temperature Probes” on page 32.

List 500: -48 VDC/-58 VDC Power System

Features

- ◆ Provides a “power” system rated for 525 A @ -48 VDC (400 A maximum per row) and 265 A @ -58 VDC @ 65°C as configured in the F2021019 cabinet.
- ◆ This is a preconfigured power system in a cabinet which is orderable by specifying cabinet F2021019. This power system is preconfigured as follows.
 - All system components mounted in rails in the F2021019 cabinet.
 - Includes a 2-row distribution cabinet.
 - Includes one (1) List FJ distribution panel in the top row.
 - Includes one (1) List AC distribution panel in the bottom row.
 - Includes the NCU controller (with custom configuration).
 - Includes a battery disconnect contactor providing low voltage battery disconnect.
 - Includes a system interface board which provides an RS485 connection point and an RJ45 CAN interface connector.
 - Includes one (1) IB2 controller interface board (provides eight (8) programmable form C- relay outputs, eight (8) programmable binary inputs, and two (2) temperature inputs). Both the relay outputs and binary inputs are all configured with customer specific requirements. Refer to the configuration drawing for those settings.
 - Includes one (1) EIB controller extended interface board (provides five (5) programmable form-C relay outputs, two (2) temperature inputs, three (3) shunt inputs, and eight (8) battery midpoint inputs). See page 12. The relay outputs are all configured with customer specific requirements. Refer to the configuration drawing for those settings.
 - Includes two (2) 10M temperature probes.
 - Includes two (2) 3M temperature probes.
 - Includes four (4) rectifier/converter shelves (three positions accept rectifiers only, three positions accept rectifiers or converters).
 - Includes cabinet rear access AC input terminal block with two rectifiers per AC feed, single phase.

Ordering Notes

- 1) Order fuses and/or circuit breakers as required per “Distribution Devices” starting on page 35.
- 2) Order input and load distribution lugs, lug adapters, and lug hardware kits as required per “Recommended Wire Sizes, Branch Circuit Protection, Crimp Lugs, and Wiring Illustrations” starting on page 49.

Vertiv™ NetSure™ 512NGBB DC Power System

System Application Guide

- 3) Order rectifier modules as required, P/N [1R482000e3](#).
- 4) Order optional -48 VDC to -58 VDC converter modules as required, P/N [1C48582000P3](#).
- 5) Order a module mounting position blank cover panel, P/N SXA1100035/1, for each empty module mounting position in the system, as desired.
- 6) A DC generator input circuit breaker kit P/N 564898 is available for field installation. This kit provides the components to install a 400 A circuit breaker to feed the rectifier output bus of the power system through a shunt. A customer connects an external generator output to this circuit breaker which then supplies generator input power to the system.

List 501: -48 VDC/-58 VDC Power System

Features

- ◆ Provides a “power” system rated for 525A @ -48 VDC (400 A maximum per row) and 265 A @ -58 VDC @ 65°C as configured in the F2020029 and F2020030 cabinets.
- ◆ This is a preconfigured power system in cabinets which are orderable by specifying F2020029 or F2020030. This power system is preconfigured as follows.
 - All system components mounted in the F2020029 or F2020030.
 - Includes a 2-row distribution cabinet.
 - Includes one (1) List FJ distribution panel in the top row.
 - Includes one (1) List AC distribution panel in the bottom row.
 - Includes the NCU controller (with a custom configuration for the F2020029 and F2020030 cabinets).
 - Includes a battery disconnect contactor providing low voltage battery disconnect.
 - Includes a system interface board which provides an RS485 connection point and an RJ45 CAN interface connector.
 - Includes one (1) IB2 controller interface board (provides eight (8) programmable form C- relay outputs, eight (8) programmable binary inputs, and two (2) temperature inputs). Both the relay outputs and binary inputs are all configured with customer specific requirements. Refer to the configuration drawing for those settings.
 - Includes one (1) EIB controller extended interface board (provides five (5) programmable form-C relay outputs, two (2) temperature inputs, three (3) shunt inputs. and eight (8) battery midpoint inputs). See page 12. The relay outputs are all configured with customer specific requirements. Refer to the configuration drawing for those settings.
 - Includes two (2) 3M temperature probes.
 - Includes four (4) rectifier/converter shelves (three positions accept rectifiers only, three positions accept rectifiers or converters).
 - Includes rear access AC input Molex connectors with two rectifiers per AC feed, single phase.
 - Includes eight (8) 553202 AC cords.

Vertiv™ NetSure™ 512NGBB DC Power System

System Application Guide

- ◆ This system includes Vertiv™ NetSure™ SPD (Surge Protection Device) Kit (P/N 60083119). This kit provides SPD (Surge Protection Device) Assemblies which are installed external to the power system. Installation materials are also provided to connect the SPD devices into a Vertiv™ NetSure™ Power System Spec. No. 582137000.

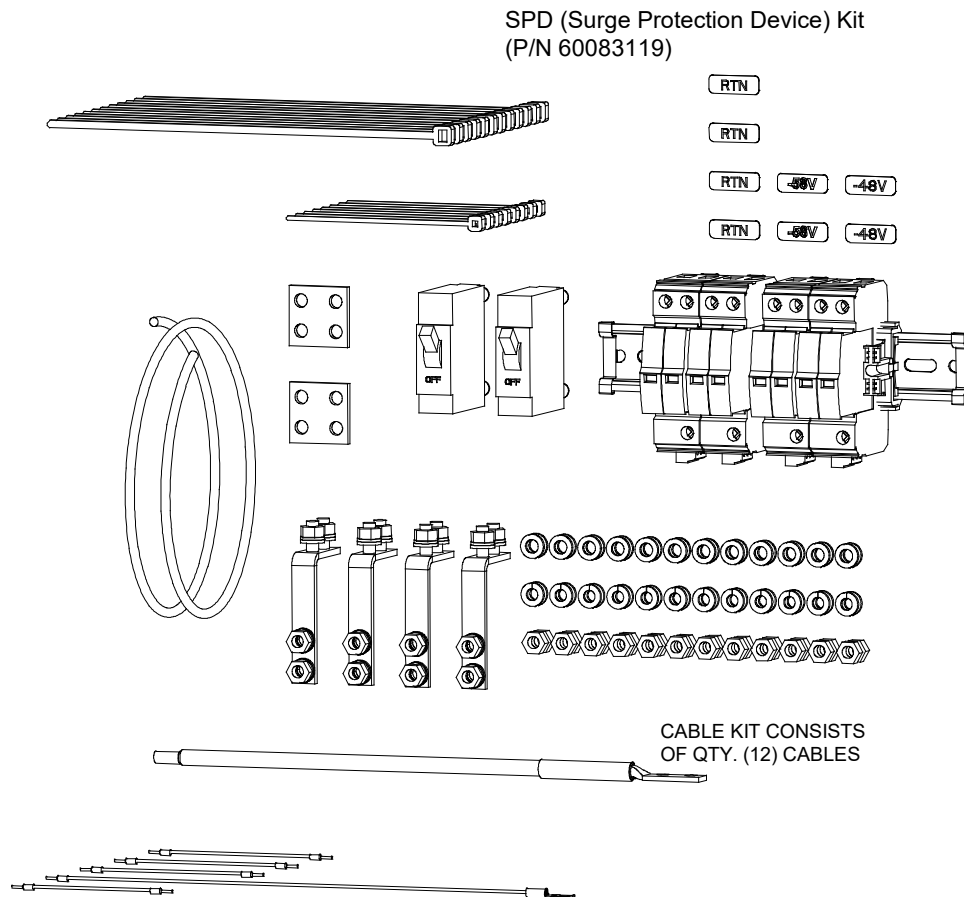

Ordering Notes

- 1) This system is ordered in cabinets F2020029 and F2020030.
- 2) Order fuses and/or circuit breakers as required per “Distribution Devices” starting on page 35.
- 3) Order input and load distribution lugs, lug adapters, and lug hardware kits as required per “Recommended Wire Sizes, Branch Circuit Protection, Crimp Lugs, and Wiring Illustrations” starting on page 49.
- 4) Order rectifier modules as required, P/N [1R4-82000e3](#).
- 5) Order optional -48 VDC to -58 VDC converter modules as required, P/N [1C48582000P3](#).
- 6) Order a module mounting position blank cover panel, P/N SXA1100035/1, for each empty module mounting position in the system, as desired.
- 7) A DC generator input circuit breaker kit P/N 564898 is available for field installation. This kit provides the components to install a 400 A circuit breaker to feed the rectifier output bus of the power system through a shunt. A customer connects an external generator output to this circuit breaker which then supplies generator input power to the system.

Single Voltage Load Distribution Panel

List AC: -48 VDC Load Distribution Panel

(30) -48 VDC Bullet/TPS/TLS Circuit Breaker/Fuse Load Positions

Features

- ◆ (30) -48 VDC Load Distribution Fuse / Circuit Breaker Mounting Positions.
 - 3A to 100A TPS/TLS Type Fuses.
 - 1A to 250A Bullet Nose Type Circuit Breakers.
 - Also accepts "[Optional 6-Position GMT Distribution Fuse Block](#)".
- ◆ 400A Maximum Capacity.

Restrictions

Unless otherwise specified fuses and/or circuit breakers are mounted from left to right, starting with the highest capacity and working to the lowest capacity.

125A to 200A circuit breakers are 2-pole devices (occupy two mounting positions).

225A to 300A circuit breakers are 3-pole devices (occupy three mounting positions).

Caution: *A circuit breaker or fuse with a rating of 80A or greater SHALL HAVE an empty mounting position between it and any other overcurrent protective device.*

Maximum lug width, 0.625 inches.

For List 27 only.

Ordering Notes

- 1) Specify row in a List 27 distribution cabinet for panel location (can be installed in top and/or bottom row). Recommend to install in bottom row so dual voltage load distribution panel can be installed in top row.
- 2) For the bottom row, order low voltage load disconnect (LVLD) [List LL](#) as required. (LVLD not available for top row.)
- 3) Order fuses and/or circuit breakers as required per "Distribution Devices" on page 35.
 - a) Order circuit breakers as required per Table 1 and Table 2.
 - b) Order fuses as required per Table 3. Also order one (1) P/N 117201 bullet nose type fuseholder per fuse ordered. Order replacement alarm fuses (18/100A) per Table 9.
- 4) Order P/N [520401](#) TVSS Device Kit(s) as required (see page 42).
- 5) Order P/N [549017](#) optional 6-position GMT fuse block as required (see page 40). Order fuses as required per Table 4.
- 6) Order load distribution lugs, lug adapters, and lug hardware kits as required per "Standard Crimp Lugs, Special Application Crimp Lugs, and Busbar Adapter Kits and Hardware Kits" on page 43.

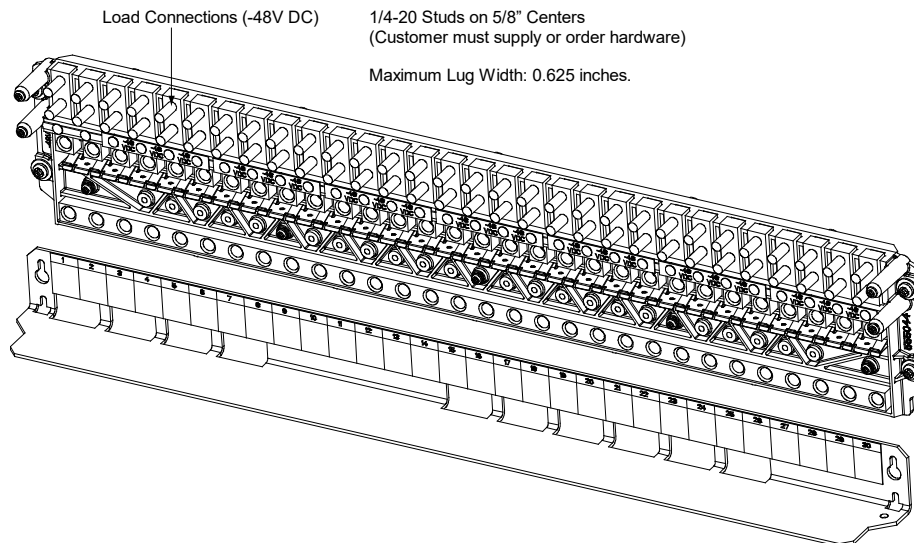

Dual Voltage Plus Battery Disconnect Distribution Panel

List BW: -48V / +24 VDC Load Distribution Plus -48 VDC Battery Disconnect Panel

(12) -48 VDC Bullet/TPS/TLS Circuit Breaker/Fuse Load Positions

(4) +24 VDC Bullet/TPS/TLS Circuit Breaker/Fuse Load Positions

(4) -48 VDC Bullet/TPS/TLS Circuit Breaker/Fuse Battery Positions

Features

- ◆ (12) -48 VDC Load Distribution Fuse / Circuit Breaker Mounting Positions.
(4) +24 VDC Load Distribution Fuse / Circuit Breaker Mounting Positions.
(4) -48 VDC Battery Distribution Fuse / Circuit Breaker Mounting Positions.
3A to 100A TPS/TLS Type Fuses.
1A to 200A Bullet Nose Type Circuit Breakers.
Also accepts "[Optional 6-Position GMT Distribution Fuse Block](#)".
- ◆ 400A Maximum Capacity.

Restrictions

Unless otherwise specified fuses and/or circuit breakers are mounted from left to right, starting with the highest capacity and working to the lowest capacity.

125A to 200A circuit breakers are 2-pole devices (occupy two mounting positions).

Caution: A -48 VDC load distribution circuit breaker or fuse with a rating of 80A or greater **SHALL HAVE** an empty mounting position between it and any other overcurrent protective device.

Maximum lug width, 0.625 inches.

For List 7 only.

Ordering Notes

- 1) Order low voltage load disconnect (LVLD) [List LL](#) (specify without busbars), as required.
- 2) Order low voltage battery disconnect (LVBD) [List CA](#) and [List LB](#) (specify 557742 wiring), as required.
- 3) Order fuses and/or circuit breakers as required per "Distribution Devices" on page 35.
 - a) Order circuit breakers as required per Table 1 and Table 2.
 - b) Order fuses as required per Table 3. Also order one (1) P/N 117201 bullet nose type fuseholder per fuse ordered. Order replacement alarm fuses (18/100A) per Table 9.
- 7) Order P/N [520401](#) TVSS Device Kit as required (see page 42).
- 8) Order P/N [545333DCP](#) 6-position GMT fuse block as required (see page 40). Order fuses as required per Table 4.
- 9) Order battery and load distribution lugs, lug adapters, and lug hardware kits as required per "Standard Crimp Lugs, Special Application Crimp Lugs, and Busbar Adapter Kits and Hardware Kits" on page 43.

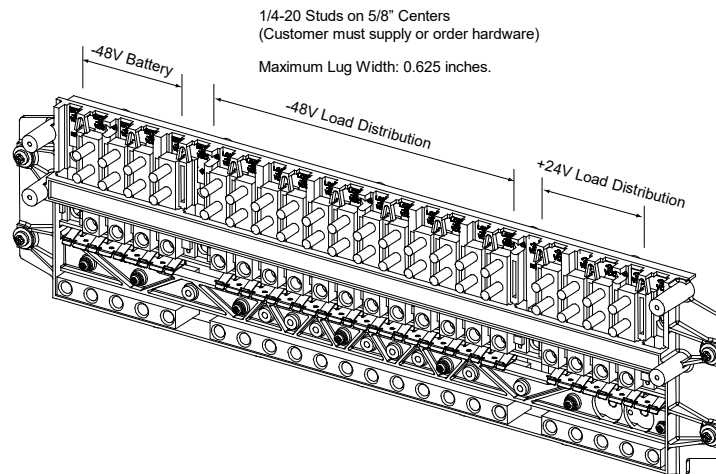

Dual Voltage Load Distribution Panel

List DH: -48V / +24 VDC Load Distribution Panel

(21) -48 VDC Bullet/TPS/TLS Circuit Breaker/Fuse Load Positions

(8) +24 VDC Bullet/TPS/TLS Circuit Breaker/Fuse Load Positions

Features

- ◆ (21) -48 VDC Load Distribution Fuse / Circuit Breaker Mounting Positions.
(8) +24 VDC Load Distribution Fuse / Circuit Breaker Mounting Positions.
3A to 100A TPS/TLS Type Fuses.
1A to 250A Bullet Nose Type Circuit Breakers.
Also accepts "[Optional 6-Position GMT Distribution Fuse Block](#)".
- ◆ 400A Maximum -48 VDC Load Distribution Capacity.
400A Maximum +24 VDC Load Distribution Capacity.

Restrictions

Must be installed in top row of a List 27 distribution cabinet.

Unless otherwise specified fuses and/or circuit breakers are mounted from the outside positions inward at each voltage potential, starting with the highest capacity and working to the lowest capacity.

125A to 200A circuit breakers are 2-pole devices (occupy two mounting positions).

225A to 250A circuit breakers are 3-pole devices (occupy three mounting positions).

Caution: *A circuit breaker or fuse with a rating of 80A or greater SHALL HAVE an empty mounting position between it and any other overcurrent protective device.*

Maximum lug width, 0.625 inches.

For List 27 only.

Ordering Notes

- 1) Order fuses and/or circuit breakers as required per "Distribution Devices" on page 35.
 - a) Order circuit breakers as required per Table 1 and Table 2.
 - b) Order fuses as required per Table 3. Also order one (1) P/N 117201 bullet nose type fuseholder per fuse ordered. Order replacement alarm fuses (18/100A) per Table 9.
- 2) Order P/N [520401](#) TVSS Device Kit(s) as required (see page 42).
- 3) Order P/N [549017](#) 6-position GMT fuse block as required (see page 40).
Order fuses as required per Table 4.
- 4) Order load distribution lugs, lug adapters, and lug hardware kits as required per "Standard Crimp Lugs, Special Application Crimp Lugs, and Busbar Adapter Kits and Hardware Kits" on page 43.

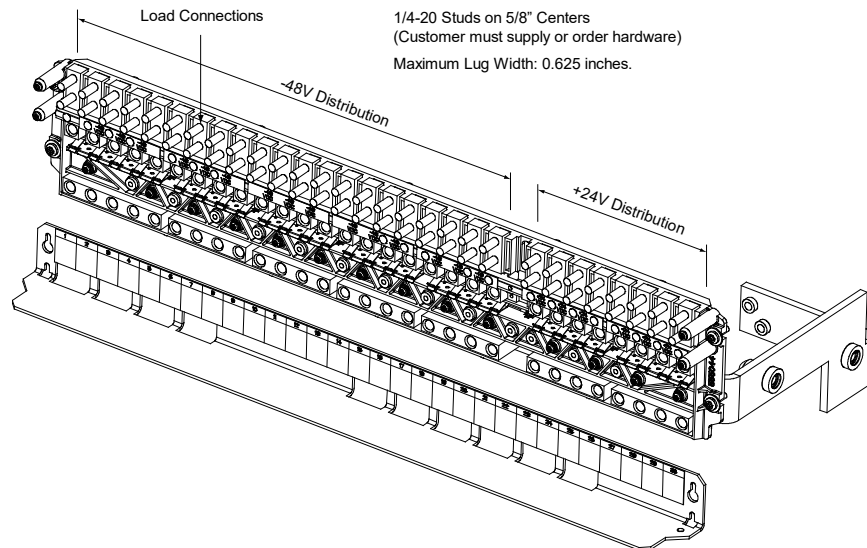

Vertiv™ NetSure™ 512NGBB DC Power System

System Application Guide

List DI: -48V / +24 VDC Load Distribution Panel

(17) -48 VDC Bullet/TPS/TLS Circuit Breaker/Fuse Load Positions

(12) +24 VDC Bullet/TPS/TLS Circuit Breaker/Fuse Load Positions

Features

- ◆ (17) -48 VDC Load Distribution Fuse / Circuit Breaker Mounting Positions.
(12) +24 VDC Load Distribution Fuse / Circuit Breaker Mounting Positions.
3A to 100A TPS/TLS Type Fuses.
1A to 250A Bullet Nose Type Circuit Breakers.
Also accepts “[Optional 6-Position GMT Distribution Fuse Block](#)”.
- ◆ 400A Maximum -48 VDC Load Distribution Capacity.
400A Maximum +24 VDC Load Distribution Capacity.

Restrictions

Must be installed in top row of a List 27 distribution cabinet.

Unless otherwise specified fuses and/or circuit breakers are mounted from the outside positions inward at each voltage potential, starting with the highest capacity and working to the lowest capacity.

125A to 200A circuit breakers are 2-pole devices (occupy two mounting positions).

225A to 250A circuit breakers are 3-pole devices (occupy three mounting positions).

Caution: *A circuit breaker or fuse with a rating of 80A or greater SHALL HAVE an empty mounting position between it and any other overcurrent protective device.*

Maximum lug width, 0.625 inches.

For List 27 only.

Ordering Notes

- 1) Order fuses and/or circuit breakers as required per “Distribution Devices” on page 35.
 - a) Order circuit breakers as required per Table 1 and Table 2.
 - b) Order fuses as required per Table 3. Also order one (1) P/N 117201 bullet nose type fuseholder per fuse ordered. Order replacement alarm fuses (18/100A) per Table 9.
- 2) Order P/N [520401](#) TVSS Device Kit(s) as required (see page 42).
- 3) Order P/N [549017](#) 6-position GMT fuse block as required (see page 40).
Order fuses as required per Table 4.
- 4) Order load distribution lugs, lug adapters, and lug hardware kits as required per “Standard Crimp Lugs, Special Application Crimp Lugs, and Busbar Adapter Kits and Hardware Kits” on page 43.

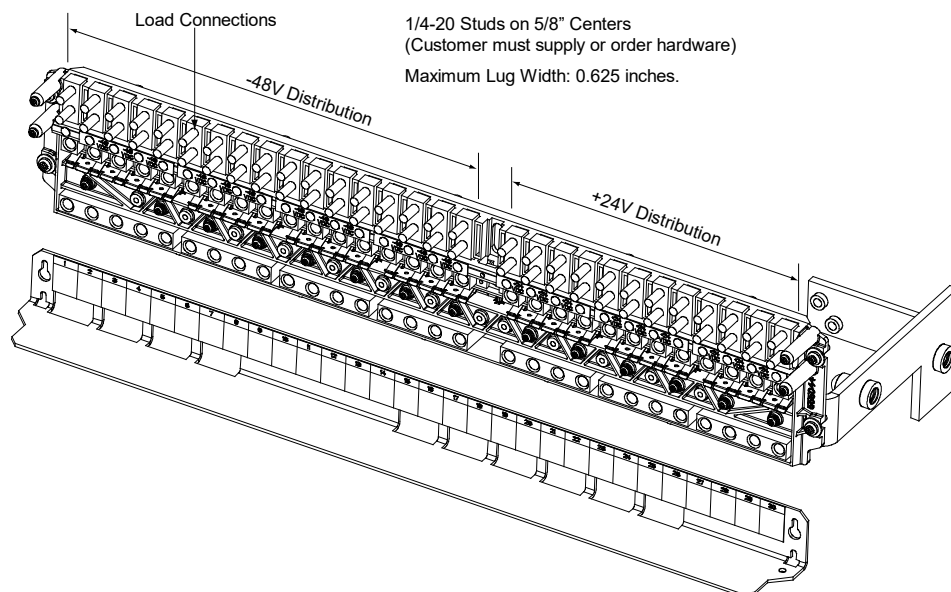

Vertiv™ NetSure™ 512NGBB DC Power System

System Application Guide

List DJ: -48V / +24 VDC Load Distribution Panel

(13) -48 VDC Bullet/TPS/TLS Circuit Breaker/Fuse Load Positions

(16) +24 VDC Bullet/TPS/TLS Circuit Breaker/Fuse Load Positions

Features

- ◆ (13) -48 VDC Load Distribution Fuse / Circuit Breaker Mounting Positions.
(16) +24 VDC Load Distribution Fuse / Circuit Breaker Mounting Positions.
3A to 100A TPS/TLS Type Fuses.
1A to 250A Bullet Nose Type Circuit Breakers.
Also accepts “[Optional 6-Position GMT Distribution Fuse Block](#)”.
- ◆ 400A Maximum -48 VDC Load Distribution Capacity.
400A Maximum +24 VDC Load Distribution Capacity.

Restrictions

Must be installed in top row of a List 27 distribution cabinet.

Unless otherwise specified fuses and/or circuit breakers are mounted from the outside positions inward at each voltage potential, starting with the highest capacity and working to the lowest capacity.

125A to 200A circuit breakers are 2-pole devices (occupy two mounting positions).

225A to 250A circuit breakers are 3-pole devices (occupy three mounting positions).

Caution: *A circuit breaker or fuse with a rating of 80A or greater SHALL HAVE an empty mounting position between it and any other overcurrent protective device.*

Maximum lug width, 0.625 inches.

For List 27 only.

Ordering Notes

- 1) Order fuses and/or circuit breakers as required per “Distribution Devices” on page 35.
 - a) Order circuit breakers as required per Table 1 and Table 2.
 - b) Order fuses as required per Table 3. Also order one (1) P/N 117201 bullet nose type fuseholder per fuse ordered. Order replacement alarm fuses (18/100A) per Table 9.
- 2) Order P/N [520401](#) TVSS Device Kit(s) as required (see page 42).
- 3) Order P/N [549017](#) 6-position GMT fuse block as required (see page 40).
Order fuses as required per Table 4.
- 4) Order load distribution lugs, lug adapters, and lug hardware kits as required per “Standard Crimp Lugs, Special Application Crimp Lugs, and Busbar Adapter Kits and Hardware Kits” on page 43.

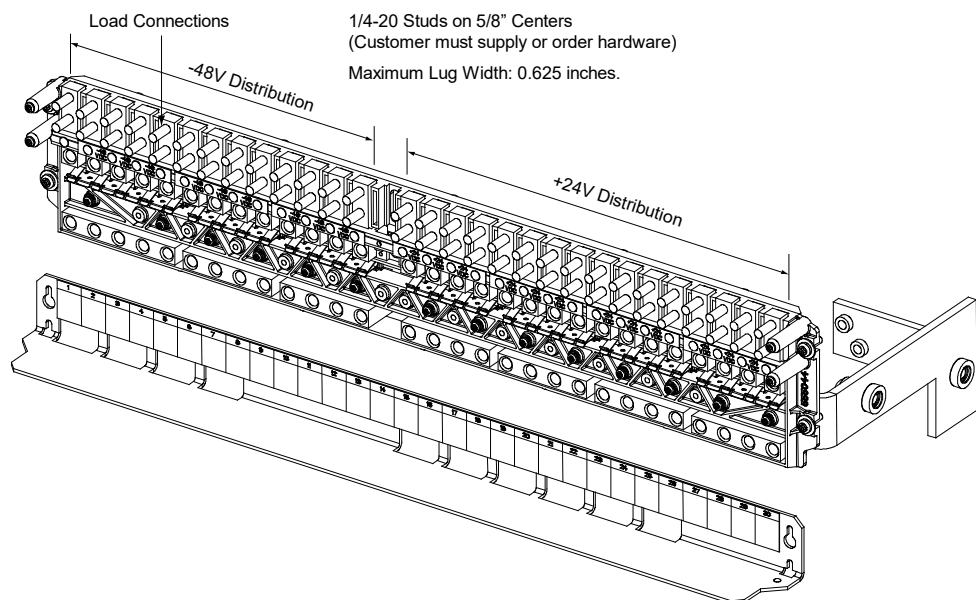

Vertiv™ NetSure™ 512NGBB DC Power System

System Application Guide

List DK: -48V / +24 VDC Load Distribution Panel

(9) -48 VDC Bullet/TPS/TLS Circuit Breaker/Fuse Load Positions

(20) +24 VDC Bullet/TPS/TLS Circuit Breaker/Fuse Load Positions

Features

- ◆ (9) -48 VDC Load Distribution Fuse / Circuit Breaker Mounting Positions.
(20) +24 VDC Load Distribution Fuse / Circuit Breaker Mounting Positions.
3A to 100A TPS/TLS Type Fuses.
1A to 250A Bullet Nose Type Circuit Breakers.
Also accepts “[Optional 6-Position GMT Distribution Fuse Block](#)”.
- ◆ 400A Maximum -48 VDC Load Distribution Capacity.
400A Maximum +24 VDC Load Distribution Capacity.

Restrictions

Must be installed in top row of a List 27 distribution cabinet.

Unless otherwise specified fuses and/or circuit breakers are mounted from the outside positions inward at each voltage potential, starting with the highest capacity and working to the lowest capacity.

125A to 200A circuit breakers are 2-pole devices (occupy two mounting positions).

225A to 250A circuit breakers are 3-pole devices (occupy three mounting positions).

Caution: *A circuit breaker or fuse with a rating of 80A or greater SHALL HAVE an empty mounting position between it and any other overcurrent protective device.*

Maximum lug width, 0.625 inches.

For List 27 only.

Ordering Notes

- 1) Order fuses and/or circuit breakers as required per “Distribution Devices” on page 35.
 - a) Order circuit breakers as required per Table 1 and Table 2.
 - b) Order fuses as required per Table 3. Also order one (1) P/N 117201 bullet nose type fuseholder per fuse ordered. Order replacement alarm fuses (18/100A) per Table 9.
- 2) Order P/N [520401](#) TVSS Device Kit(s) as required (see page 42).
- 3) Order P/N [549017](#) 6-position GMT fuse block as required (see page 40).
Order fuses as required per Table 4.
- 4) Order load distribution lugs, lug adapters, and lug hardware kits as required per “Standard Crimp Lugs, Special Application Crimp Lugs, and Busbar Adapter Kits and Hardware Kits” on page 43.

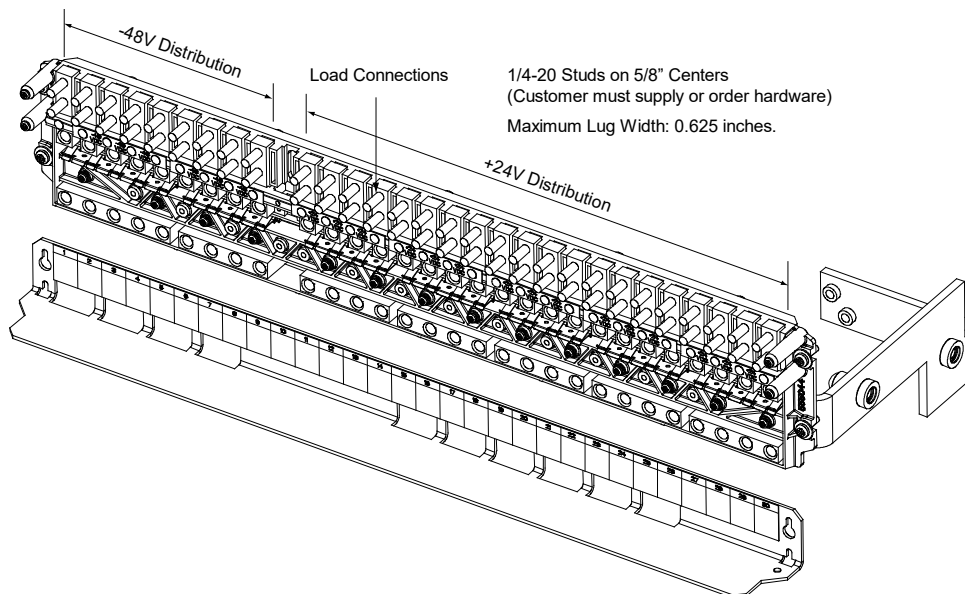

Vertiv™ NetSure™ 512NGBB DC Power System

System Application Guide

List DL: -48V / +24 VDC Load Distribution Panel

(5) -48 VDC Bullet/TPS/TLS Circuit Breaker/Fuse Load Positions

(24) +24 VDC Bullet/TPS/TLS Circuit Breaker/Fuse Load Positions

Features

- ◆ (5) -48 VDC Load Distribution Fuse / Circuit Breaker Mounting Positions.
(24) +24 VDC Load Distribution Fuse / Circuit Breaker Mounting Positions.
3A to 100A TPS/TLS Type Fuses.
1A to 250A Bullet Nose Type Circuit Breakers.
Also accepts “[Optional 6-Position GMT Distribution Fuse Block](#)”.
- ◆ 400A Maximum -48 VDC Load Distribution Capacity.
400A Maximum +24 VDC Load Distribution Capacity.

Restrictions

Must be installed in top row of a List 27 distribution cabinet.

Unless otherwise specified fuses and/or circuit breakers are mounted from the outside positions inward at each voltage potential, starting with the highest capacity and working to the lowest capacity.

125A to 200A circuit breakers are 2-pole devices (occupy two mounting positions).

225A to 250A circuit breakers are 3-pole devices (occupy three mounting positions).

Caution: *A circuit breaker or fuse with a rating of 80A or greater SHALL HAVE an empty mounting position between it and any other overcurrent protective device.*

Maximum lug width, 0.625 inches.

For List 27 only.

Ordering Notes

- 1) Order fuses and/or circuit breakers as required per “Distribution Devices” on page 35.
 - a) Order circuit breakers as required per Table 1 and Table 2.
 - b) Order fuses as required per Table 3. Also order one (1) P/N 117201 bullet nose type fuseholder per fuse ordered. Order replacement alarm fuses (18/100A) per Table 9.
- 2) Order P/N [520401](#) TVSS Device Kit(s) as required (see page 42).
- 3) Order P/N [549017](#) 6-position GMT fuse block as required (see page 40). Order fuses as required per Table 4.
- 4) Order load distribution lugs, lug adapters, and lug hardware kits as required per “Standard Crimp Lugs, Special Application Crimp Lugs, and Busbar Adapter Kits and Hardware Kits” on page 43.

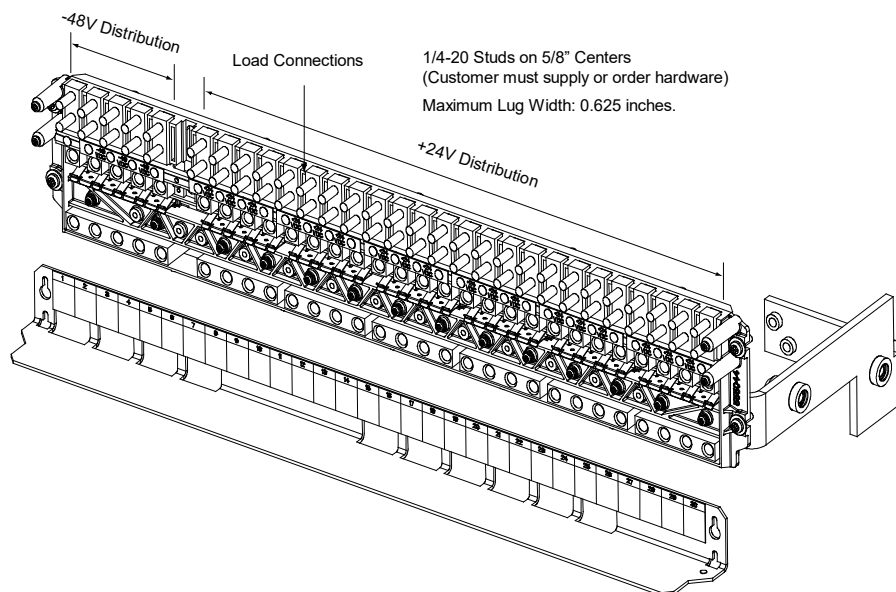

Vertiv™ NetSure™ 512NGBB DC Power System

System Application Guide

List FG: -48V / -58 VDC Load Distribution Panel

(25) -48 VDC Bullet/TPS/TLS Circuit Breaker/Fuse Load Positions

(4) -58 VDC Bullet/TPS/TLS Circuit Breaker/Fuse Load Positions

Features

- ◆ (25) -48 VDC Load Distribution Fuse / Circuit Breaker Mounting Positions.
(4) -58 VDC Load Distribution Fuse / Circuit Breaker Mounting Positions.
3A to 100A TPS/TLS Type Fuses.
1A to 250A Bullet Nose Type Circuit Breakers.
Also accepts “[Optional 6-Position GMT Distribution Fuse Block](#)”.
- ◆ 400A Maximum -48 VDC Load Distribution Capacity.
300A Maximum -58 VDC Maximum Load Distribution Capacity.

Restrictions

Must be installed in top row of a List 27 distribution cabinet.

Unless otherwise specified fuses and/or circuit breakers are mounted from the outside positions inward at each voltage potential, starting with the highest capacity and working to the lowest capacity.

125A to 200A circuit breakers are 2-pole devices (occupy two mounting positions).

225A to 300A circuit breakers are 3-pole devices (occupy three mounting positions).

Caution: *A circuit breaker or fuse with a rating of 80A or greater SHALL HAVE an empty mounting position between it and any other overcurrent protective device.*

Maximum lug width, 0.625 inches.

For List 27 only.

Ordering Notes

- 1) Order fuses and/or circuit breakers as required per “Distribution Devices” on page 35.
 - a) Order circuit breakers as required per Table 1 and Table 2.
 - b) Order fuses as required per Table 3. Also order one (1) P/N 117201 bullet nose type fuseholder per fuse ordered. Order replacement alarm fuses (18/100A) per Table 9.
- 2) Order P/N [520401](#) TVSS Device Kit(s) as required (see page 42).
- 3) Order P/N [549017](#) 6-position GMT fuse block as required (see page 40).
Order fuses as required per Table 4.
- 4) Order load distribution lugs, lug adapters, and lug hardware kits as required per “Standard Crimp Lugs, Special Application Crimp Lugs, and Busbar Adapter Kits and Hardware Kits” on page 43.

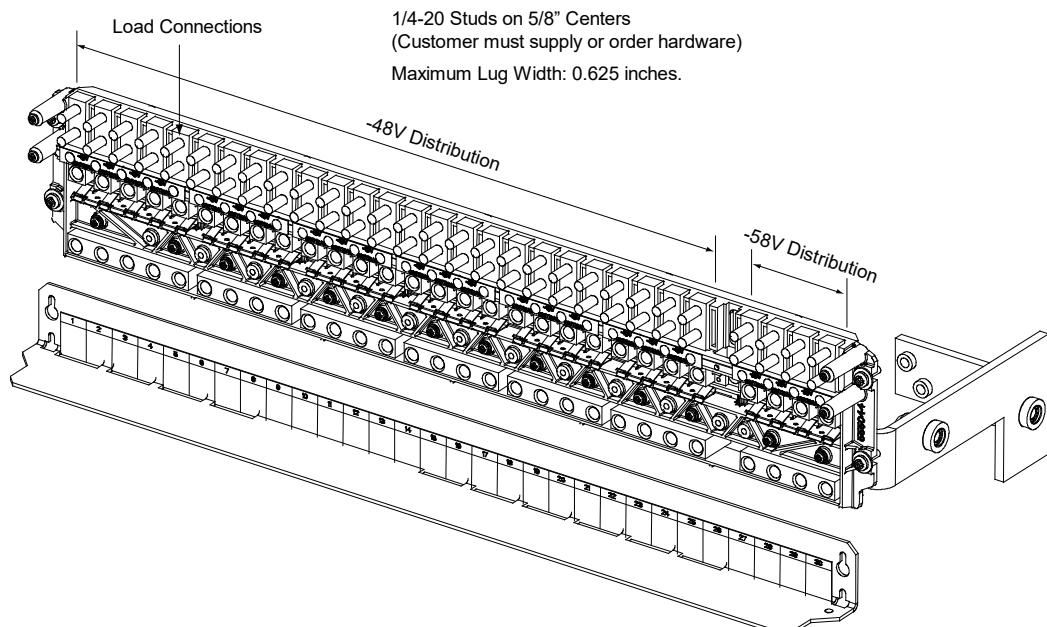

Vertiv™ NetSure™ 512NGBB DC Power System

System Application Guide

List FH: -48V / -58 VDC Load Distribution Panel

(21) -48 VDC Bullet/TPS/TLS Circuit Breaker/Fuse Load Positions

(8) -58 VDC Bullet/TPS/TLS Circuit Breaker/Fuse Load Positions

Features

- ◆ (21) -48 VDC Load Distribution Fuse / Circuit Breaker Mounting Positions.
(8) -58 VDC Load Distribution Fuse / Circuit Breaker Mounting Positions.
3A to 100A TPS/TLS Type Fuses.
1A to 250A Bullet Nose Type Circuit Breakers.
Also accepts “[Optional 6-Position GMT Distribution Fuse Block](#)”.
- ◆ 400A Maximum -48 VDC Load Distribution Capacity.
300A Maximum -58 VDC Maximum Load Distribution Capacity.

Restrictions

Must be installed in top row of a List 27 distribution cabinet.

Unless otherwise specified fuses and/or circuit breakers are mounted from the outside positions inward at each voltage potential, starting with the highest capacity and working to the lowest capacity.

125A to 200A circuit breakers are 2-pole devices (occupy two mounting positions).

225A to 300A circuit breakers are 3-pole devices (occupy three mounting positions).

Caution: *A circuit breaker or fuse with a rating of 80A or greater SHALL HAVE an empty mounting position between it and any other overcurrent protective device.*

Maximum lug width, 0.625 inches.

For List 27 only.

Ordering Notes

- 1) Order fuses and/or circuit breakers as required per “Distribution Devices” on page 35.
 - a) Order circuit breakers as required per Table 1 and Table 2.
 - b) Order fuses as required per Table 3. Also order one (1) P/N 117201 bullet nose type fuseholder per fuse ordered.
Order replacement alarm fuses (18/100A) per Table 9.
- 2) Order P/N [520401](#) TVSS Device Kit(s) as required (see page 42).
- 3) Order P/N [549017](#) 6-position GMT fuse block as required (see page 40).
Order fuses as required per Table 4.
- 4) Order load distribution lugs, lug adapters, and lug hardware kits as required per “Standard Crimp Lugs, Special Application Crimp Lugs, and Busbar Adapter Kits and Hardware Kits” on page 43.

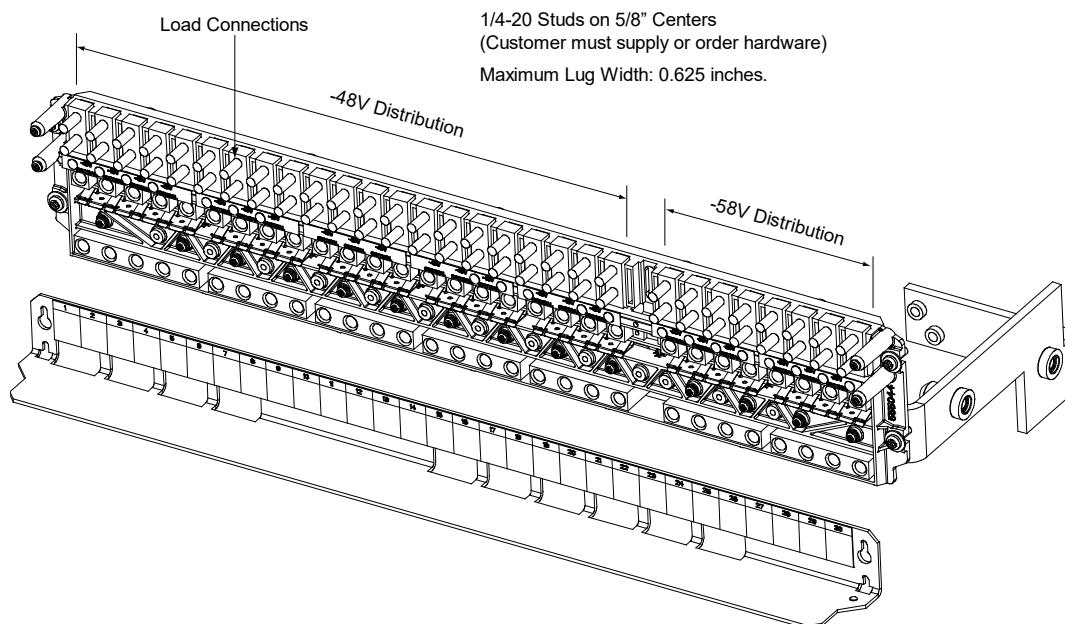

Vertiv™ NetSure™ 512NGBB DC Power System

System Application Guide

List FI: -48V / -58 VDC Load Distribution Panel

(17) -48 VDC Bullet/TPS/TLS Circuit Breaker/Fuse Load Positions

(12) -58 VDC Bullet/TPS/TLS Circuit Breaker/Fuse Load Positions

Features

- ◆ (17) -48 VDC Load Distribution Fuse / Circuit Breaker Mounting Positions.
(12) -58 VDC Load Distribution Fuse / Circuit Breaker Mounting Positions.
3A to 100A TPS/TLS Type Fuses.
1A to 250A Bullet Nose Type Circuit Breakers.
Also accepts “[Optional 6-Position GMT Distribution Fuse Block](#)”.
- ◆ 400A Maximum -48 VDC Load Distribution Capacity.
300A Maximum -58 VDC Maximum Load Distribution Capacity.

Restrictions

Must be installed in top row of a List 27 distribution cabinet.

Unless otherwise specified fuses and/or circuit breakers are mounted from the outside positions inward at each voltage potential, starting with the highest capacity and working to the lowest capacity.

125A to 200A circuit breakers are 2-pole devices (occupy two mounting positions).

225A to 300A circuit breakers are 3-pole devices (occupy three mounting positions).

Caution: *A circuit breaker or fuse with a rating of 80A or greater SHALL HAVE an empty mounting position between it and any other overcurrent protective device.*

Maximum lug width, 0.625 inches.

For List 27 only.

Ordering Notes

- 1) Order fuses and/or circuit breakers as required per “Distribution Devices” on page 35.
 - a) Order circuit breakers as required per Table 1 and Table 2.
 - b) Order fuses as required per Table 3. Also order one (1) P/N 117201 bullet nose type fuseholder per fuse ordered. Order replacement alarm fuses (18/100A) per Table 9.
- 2) Order P/N [520401](#) TVSS Device Kit(s) as required (see page 42).
- 3) Order P/N [549017](#) 6-position GMT fuse block as required (see page 40).
Order fuses as required per Table 4.
- 4) Order load distribution lugs, lug adapters, and lug hardware kits as required per “Standard Crimp Lugs, Special Application Crimp Lugs, and Busbar Adapter Kits and Hardware Kits” on page 43.

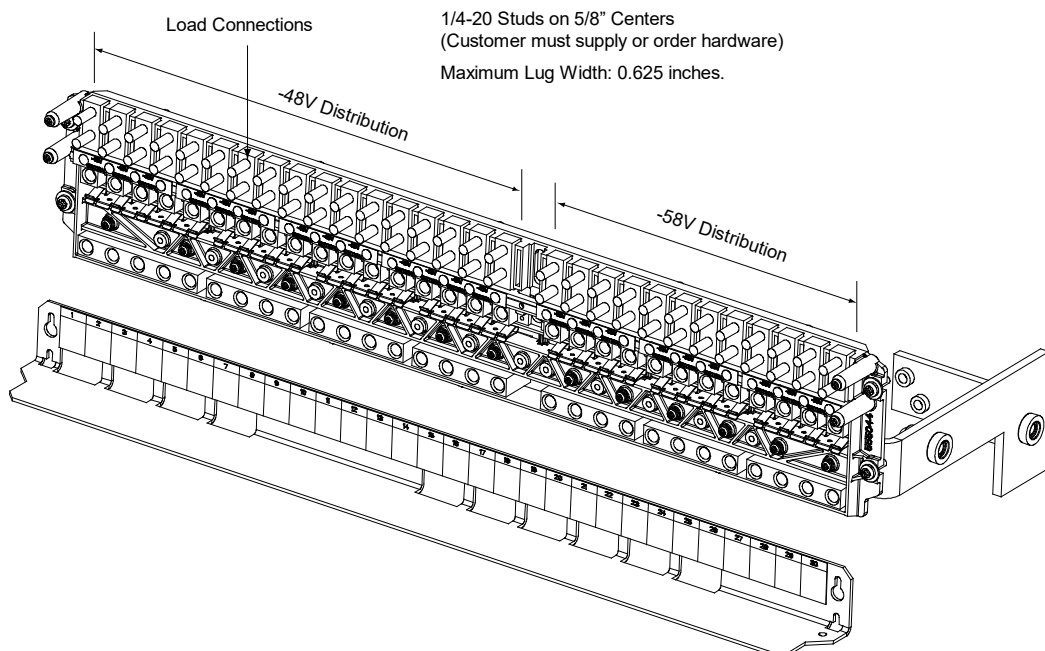

Vertiv™ NetSure™ 512NGBB DC Power System

System Application Guide

List FJ: -48V / -58 VDC Load Distribution Panel

(13) -48 VDC Bullet/TPS/TLS Circuit Breaker/Fuse Load Positions
(16) -58 VDC Bullet/TPS/TLS Circuit Breaker/Fuse Load Positions

Features

- ◆ (13) -48 VDC Load Distribution Fuse / Circuit Breaker Mounting Positions.
(16) -58 VDC Load Distribution Fuse / Circuit Breaker Mounting Positions.
3A to 100A TPS/TLS Type Fuses.
1A to 250A Bullet Nose Type Circuit Breakers.
Also accepts "[Optional 6-Position GMT Distribution Fuse Block](#)".
- ◆ 400A Maximum -48 VDC Load Distribution Capacity.
300A Maximum -58 VDC Maximum Load Distribution Capacity.

Restrictions

Must be installed in top row of a List 27 distribution cabinet.

Unless otherwise specified fuses and/or circuit breakers are mounted from the outside positions inward at each voltage potential, starting with the highest capacity and working to the lowest capacity.

125A to 200A circuit breakers are 2-pole devices (occupy two mounting positions).

225A to 300A circuit breakers are 3-pole devices (occupy three mounting positions).

Caution: *A circuit breaker or fuse with a rating of 80A or greater SHALL HAVE an empty mounting position between it and any other overcurrent protective device.*

Maximum lug width, 0.625 inches.

For List 27 only.

Ordering Notes

- 1) Order fuses and/or circuit breakers as required per "Distribution Devices" on page 35.
 - a) Order circuit breakers as required per Table 1 and Table 2.
 - b) Order fuses as required per Table 3. Also order one (1) P/N 117201 bullet nose type fuseholder per fuse ordered. Order replacement alarm fuses (18/100A) per Table 9.
- 2) Order P/N [520401](#) TVSS Device Kit(s) as required (see page 42).
- 3) Order P/N [549017](#) 6-position GMT fuse block as required (see page 40).
Order fuses as required per Table 4.
- 4) Order load distribution lugs, lug adapters, and lug hardware kits as required per "Standard Crimp Lugs, Special Application Crimp Lugs, and Busbar Adapter Kits and Hardware Kits" on page 43.

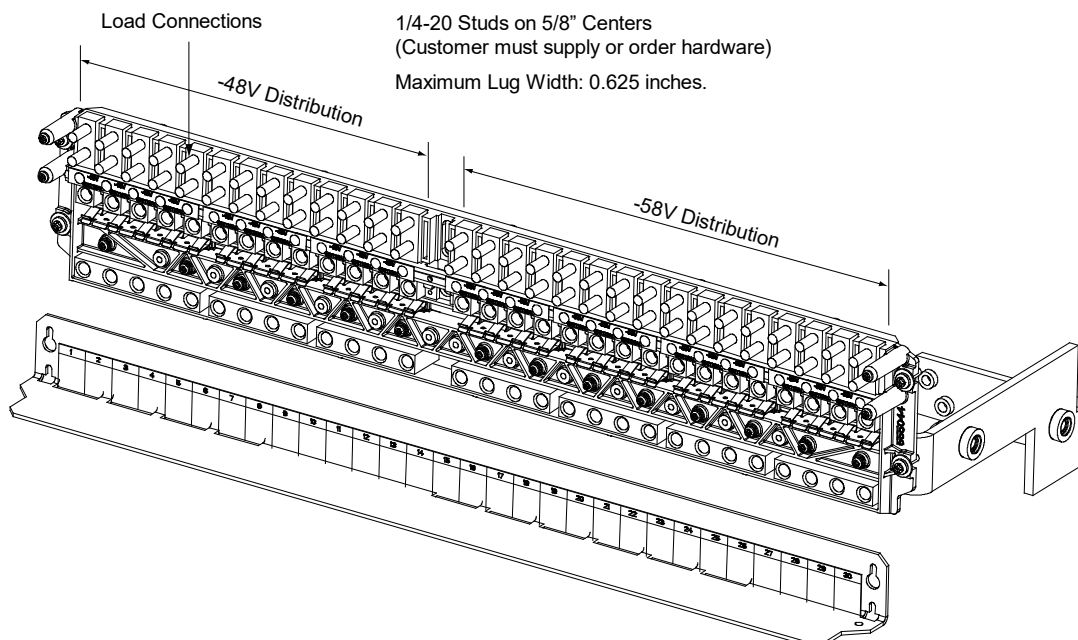

Vertiv™ NetSure™ 512NGBB DC Power System

System Application Guide

List FK: -48V / -58 VDC Load Distribution Panel

(9) -48 VDC Bullet/TPS/TLS Circuit Breaker/Fuse Load Positions

(20) -58 VDC Bullet/TPS/TLS Circuit Breaker/Fuse Load Positions

Features

- ◆ (9) -48 VDC Load Distribution Fuse / Circuit Breaker Mounting Positions.
(20) -58 VDC Load Distribution Fuse / Circuit Breaker Mounting Positions.
3A to 100A TPS/TLS Type Fuses.
1A to 250A Bullet Nose Type Circuit Breakers.
Also accepts “[Optional 6-Position GMT Distribution Fuse Block](#)”.
- ◆ 400A Maximum -48 VDC Load Distribution Capacity.
300A Maximum -58 VDC Maximum Load Distribution Capacity.

Restrictions

Must be installed in top row of a List 27 distribution cabinet.

Unless otherwise specified fuses and/or circuit breakers are mounted from the outside positions inward at each voltage potential, starting with the highest capacity and working to the lowest capacity.

125A to 200A circuit breakers are 2-pole devices (occupy two mounting positions).

225A to 300A circuit breakers are 3-pole devices (occupy three mounting positions).

Caution: *A circuit breaker or fuse with a rating of 80A or greater SHALL HAVE an empty mounting position between it and any other overcurrent protective device.*

Maximum lug width, 0.625 inches.

For List 27 only.

Ordering Notes

- 1) Order fuses and/or circuit breakers as required per “Distribution Devices” on page 35.
 - a) Order circuit breakers as required per Table 1 and Table 2.
 - b) Order fuses as required per Table 3. Also order one (1) P/N 117201 bullet nose type fuseholder per fuse ordered. Order replacement alarm fuses (18/100A) per Table 9.
- 2) Order P/N [520401](#) TVSS Device Kit(s) as required (see page 42).
- 3) Order P/N [549017](#) 6-position GMT fuse block as required (see page 40). Order fuses as required per Table 4.
- 4) Order load distribution lugs, lug adapters, and lug hardware kits as required per “Standard Crimp Lugs, Special Application Crimp Lugs, and Busbar Adapter Kits and Hardware Kits” on page 43.

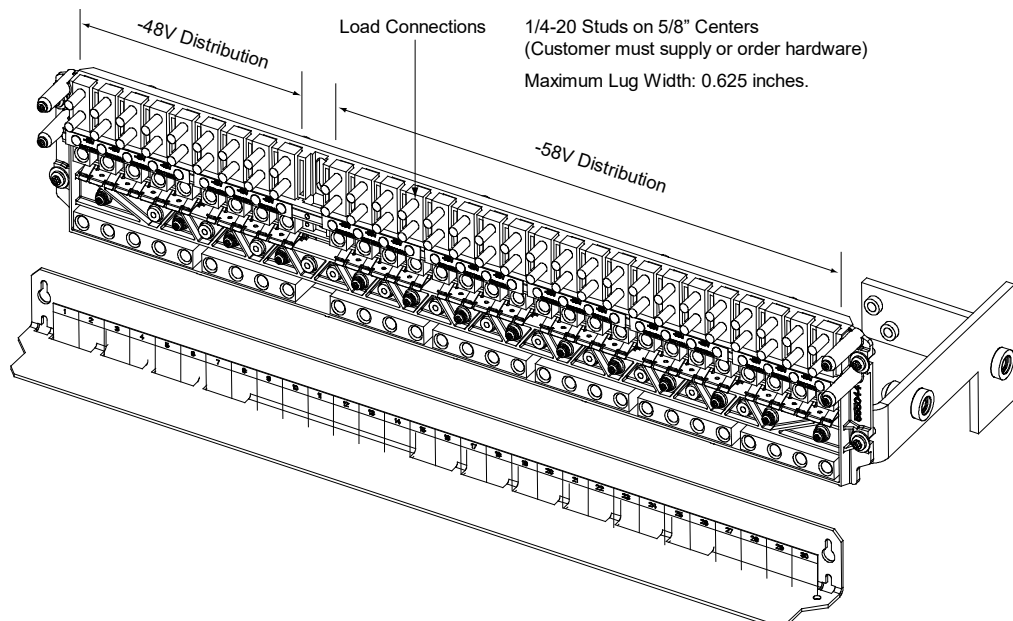

Vertiv™ NetSure™ 512NGBB DC Power System

System Application Guide

List FL: -48V / -58 VDC Load Distribution Panel

(5) -48 VDC Bullet/TPS/TLS Circuit Breaker/Fuse Load Positions

(24) -58 VDC Bullet/TPS/TLS Circuit Breaker/Fuse Load Positions

Features

- ◆ (5) -48 VDC Load Distribution Fuse / Circuit Breaker Mounting Positions.
(24) -58 VDC Load Distribution Fuse / Circuit Breaker Mounting Positions.
3A to 100A TPS/TLS Type Fuses.
1A to 250A Bullet Nose Type Circuit Breakers.
Also accepts “[Optional 6-Position GMT Distribution Fuse Block](#)”.
- ◆ 400A Maximum -48 VDC Load Distribution Capacity.
300A Maximum -58 VDC Maximum Load Distribution Capacity.

Restrictions

Must be installed in top row of a List 27 distribution cabinet.

Unless otherwise specified fuses and/or circuit breakers are mounted from the outside positions inward at each voltage potential, starting with the highest capacity and working to the lowest capacity.

125A to 200A circuit breakers are 2-pole devices (occupy two mounting positions).

225A to 300A circuit breakers are 3-pole devices (occupy three mounting positions).

Caution: *A circuit breaker or fuse with a rating of 80A or greater SHALL HAVE an empty mounting position between it and any other overcurrent protective device.*

Maximum lug width, 0.625 inches.

For List 27 only.

Ordering Notes

- 1) Order fuses and/or circuit breakers as required per “Distribution Devices” on page 35.
 - a) Order circuit breakers as required per Table 1 and Table 2.
 - b) Order fuses as required per Table 3. Also order one (1) P/N 117201 bullet nose type fuseholder per fuse ordered. Order replacement alarm fuses (18/100A) per Table 9.
- 2) Order P/N [520401](#) TVSS Device Kit(s) as required (see page 42).
- 3) Order P/N [549017](#) 6-position GMT fuse block as required (see page 40).
Order fuses as required per Table 4.
- 4) Order load distribution lugs, lug adapters, and lug hardware kits as required per “Standard Crimp Lugs, Special Application Crimp Lugs, and Busbar Adapter Kits and Hardware Kits” on page 43.

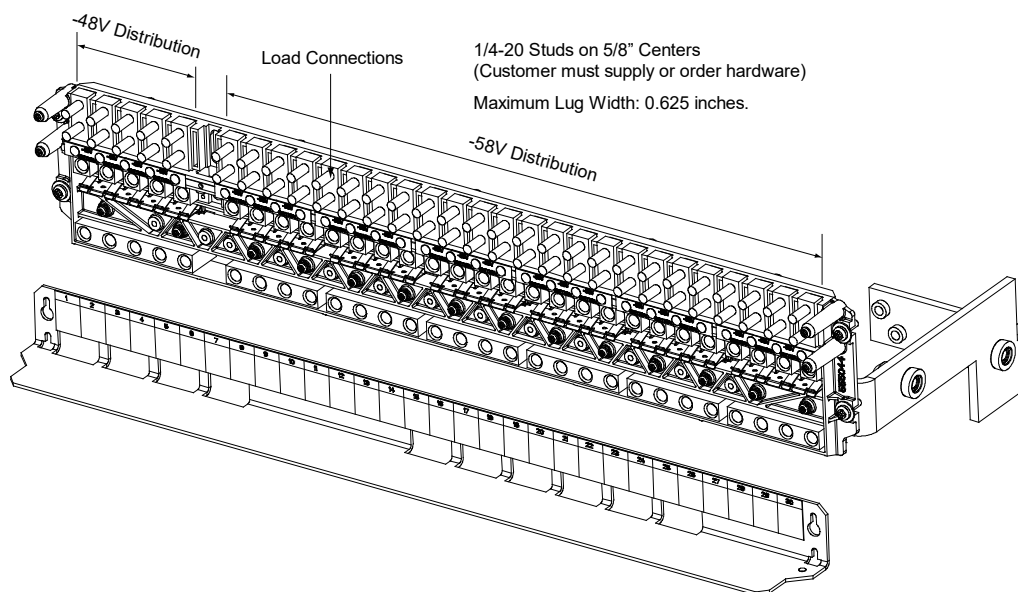

Vertiv™ NetSure™ 512NGBB DC Power System

System Application Guide

List FM: -58 VDC Load Distribution Panel

(29) -58 VDC Bullet/TPS/TLS Circuit Breaker/Fuse Load Positions

Features

- ◆ (29) -58 VDC Load Distribution Fuse / Circuit Breaker Mounting Positions.
 - 3A to 100A TPS/TLS Type Fuses.
 - 1A to 250A Bullet Nose Type Circuit Breakers.
 - Also accepts “[Optional 6-Position GMT Distribution Fuse Block](#)”.
- ◆ 300A Maximum -58 VDC Maximum Load Distribution Capacity.

Restrictions

Must be installed in top row of a List 27 distribution cabinet.

Unless otherwise specified fuses and/or circuit breakers are mounted from the outside positions inward at each voltage potential, starting with the highest capacity and working to the lowest capacity.

125A to 200A circuit breakers are 2-pole devices (occupy two mounting positions).

225A to 300A circuit breakers are 3-pole devices (occupy three mounting positions).

Caution: *A circuit breaker or fuse with a rating of 80A or greater SHALL HAVE an empty mounting position between it and any other overcurrent protective device.*

Maximum lug width, 0.625 inches.

For List 27 only.

Ordering Notes

- 1) Order fuses and/or circuit breakers as required per “Distribution Devices” on page 35.
 - a) Order circuit breakers as required per Table 1 and Table 2.
 - b) Order fuses as required per Table 3. Also order one (1) P/N 117201 bullet nose type fuseholder per fuse ordered. Order replacement alarm fuses (18/100A) per Table 9.
- 2) Order P/N [520401](#) TVSS Device Kit(s) as required (see page 42).
- 3) Order P/N [549017](#) 6-position GMT fuse block as required (see page 40). Order fuses as required per Table 4.
- 4) Order load distribution lugs, lug adapters, and lug hardware kits as required per “Standard Crimp Lugs, Special Application Crimp Lugs, and Busbar Adapter Kits and Hardware Kits” on page 43.

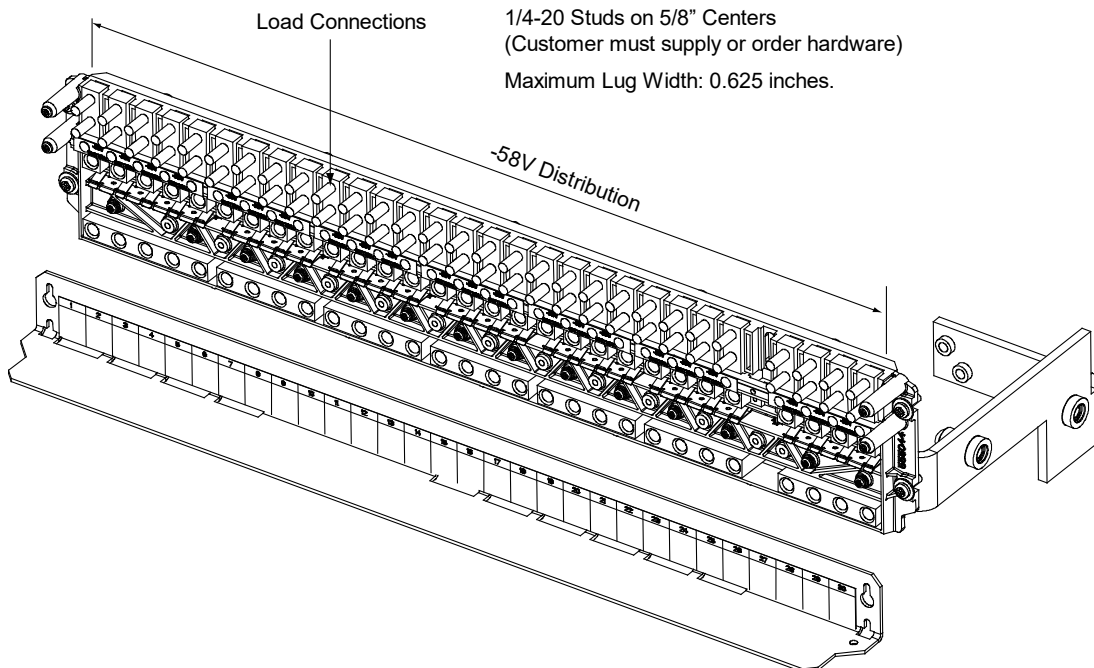

Vertiv™ NetSure™ 512NGBB DC Power System

System Application Guide

List GC: -58 VDC Load Distribution Panel

(30) -58 VDC Bullet/TPS/TLS Circuit Breaker/Fuse Load Positions

Features

- ◆ (30) -58 VDC Load Distribution Fuse / Circuit Breaker Mounting Positions.
 - 3A to 100A TPS/TLS Type Fuses.
 - 1A to 250A Bullet Nose Type Circuit Breakers.
 - Also accepts “[Optional 6-Position GMT Distribution Fuse Block](#)”.
- ◆ 300A Maximum -58 VDC Maximum Load Distribution Capacity.

Restrictions

Must be installed in bottom row of a List 27 distribution cabinet.

The List GC cannot be used with List DH-DL panels in the top row.

Unless otherwise specified fuses and/or circuit breakers are mounted from left to right, starting with the highest capacity and working to the lowest capacity.

125A to 200A circuit breakers are 2-pole devices (occupy two mounting positions).

225A to 300A circuit breakers are 3-pole devices (occupy three mounting positions).

Caution: *A circuit breaker or fuse with a rating of 80A or greater SHALL HAVE an empty mounting position between it and any other overcurrent protective device.*

Maximum lug width, 0.625 inches.

For List 27 only.

Ordering Notes

- 1) Order fuses and/or circuit breakers as required per “Distribution Devices” on page 35.
 - a) Order circuit breakers as required per Table 1 and Table 2.
 - b) Order fuses as required per Table 3. Also order one (1) P/N 117201 bullet nose type fuseholder per fuse ordered. Order replacement alarm fuses (18/100A) per Table 9.
- 2) Order P/N [520401](#) TVSS Device Kit(s) as required (see page 42).
- 3) Order P/N [549017](#) 6-position GMT fuse block as required (see page 40). Order fuses as required per Table 4.
- 4) Order load distribution lugs, lug adapters, and lug hardware kits as required per “Standard Crimp Lugs, Special Application Crimp Lugs, and Busbar Adapter Kits and Hardware Kits” on page 43.

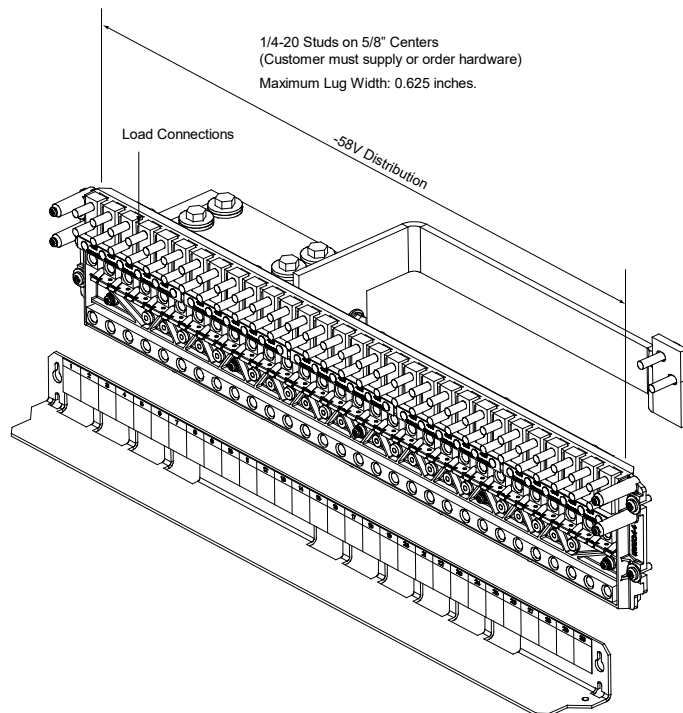

Battery Disconnect Contactor

List CA: 600A Battery Disconnect Contactor

Features

- ◆ Provides a battery disconnect contactor which is mounted inside the distribution cabinet.

Restrictions

Must be used with List LB, MB, or both.

Ordering Notes

- 1) Order as required.

Low Voltage Disconnect Options

List LB: Low Voltage Battery Disconnect (LVBD) Wiring

Features

- ◆ Adds low voltage battery disconnect (LVBD) to the distribution cabinet.

Restrictions

Must be used with List CA.

Ordering Notes

- 1) Order if low voltage battery disconnect (LVBD) is required.
Note: Can be combined with manual battery disconnect (List MB) if required.
- 2) Specify jumper option per application.
 - a) P/N 557742 for use with List 7.
 - b) P/N 555855 for use with List 27.

List LL: Low Voltage Load Disconnect (LVLD)

Features

- ◆ Adds low voltage load disconnect (LVLD) to a distribution panel.

Restrictions

In a List 27 distribution cabinet, must be used with List AC distribution panel installed in bottom row only.

In a List 7 distribution cabinet, specify without busbars.

Ordering Notes

- 1) Order if low voltage load disconnect (LVLD) is required.

Manual Battery Disconnect Option

List MB: Manual Battery Disconnect

Features

- ◆ Adds manual battery disconnect to the distribution cabinet.
- ◆ Adds manual disconnect circuit card P/N 540973 to the distribution cabinet.

Restrictions

Must be used with List CA.

Not for use in List 7.

Ordering Notes

- 1) Order if manual battery disconnect is required.
Note: Can be combined with low voltage battery disconnect (List LB) if required.

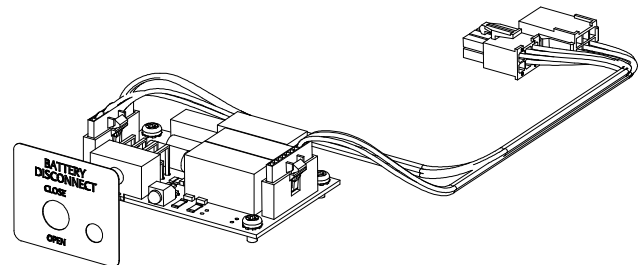

ACCESSORY DESCRIPTIONS

Controller

NCU (NetSure Control Unit) Controller, P/N 1M830DNA or 1M830BNA

Features

- ◆ Provides the NCU Controller, Model M830B (Spec. No. 1M830BNA) or Model M830D (Spec. No. 1M830DNA).
- ◆ Factory programmed with the configuration file required for the system configuration ordered.

Note: For custom NCU configurations, contact Vertiv.

Restrictions

Only one (1) controller per power system is required.

Ordering Notes

- 1) Order one (1) controller per power system. NCU controller options are as follows.
 - a) P/N 1M830BNA for use with List 7 distribution cabinet (installed in a 588705300 module mounting shelf).
 - b) P/N 1M830DNA for use with List 27 distribution cabinet (installed in 582137000 List 27 distribution cabinet).
- 2) For List 27 distribution cabinet, order optional [List 70](#) EIB Controller extended interface board as required (see page 12).
- 3) Order up to four (4) optional temperature probes for ambient and battery temperature monitoring, as required. The temperature probe(s) may also be used for the battery charge temperature compensation feature and BTRM (Battery Thermal Runaway Management). Refer to “Optional Temperature Probes” on page 32 for additional information.
- 4) Order optional supervisory modules as desired (shipped loose).

- [SM-TEMP](#) (Supervisory Module for Temperature Probes).

Note: A system can have up to (8) SM-Temp modules for a total of sixty-eight (68) temperature probes that can be used in the power system for ambient and battery monitoring.

- 5) Ordering an NCU for replacing an NCU or as a spare NCU.

If the NCU is to be used as a replacement in a specific system it should be ordered with the same configuration file as the original NCU controller. This is identified by a six digit number. If the controller part number ends with a six digit number, for example, 1M830BNA559242, the configuration file number is the last six characters. If the part number does not have these characters, the configuration file number can be found on the controller nameplate – “Programmed with Configuration File #####”. The controller may also have a Unique Identification Number (UIN). This number indicates that certain parameters were set at the factory to match the controller to the options selected with the power plant (such as low voltage disconnect, load and battery shunt ratings, etc.). If the controller has a UIN, the plant will have shipped with a USB drive labelled with the UIN. The UIN label may also be located near the controller slot in the system. If the controller has a UIN, provide this UIN number, along with the configuration number, when ordering so that the new controller will match that of the original controller shipped with the system. The user manual provided with the controller provides instructions for replacing and programming the controller. It is important to follow these instructions carefully. The user manual also provides instructions for saving certain controller files that are created when changes are made to the system after leaving the factory. These files can be programmed into the replacement controller so it can match the latest saved state of the original controller.

If the NCU is being ordered as a spare part for any of a group of power plants, the same procedure can be followed. If the replacement controller’s configuration does not match that of the original controller, the original files can be retrieved from the USB drive shipped with the plant, if available. If the USB drive is not available, contact the factory or technical assistance center to obtain a copy of the original configuration file (all package) so it can be programmed into the new controller.

The NCU programming files are unique to the NCU. Files from an SCU+ or ACU+ are not compatible with the NCU and MUST NOT BE loaded into an NCU.

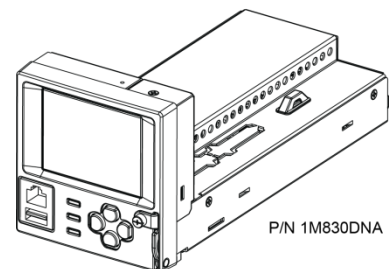
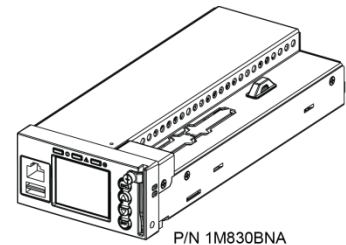

Optional Temperature Probes

Features

- ◆ Up to two (2) temperature probes can be connected to the IB2 (Controller Interface Board). Up to two (2) additional temperature probes can be connected to the EIB (Controller Extended Interface Board). Any combination of the four (4) temperature probes can be programmed to monitor ambient temperature and/or battery temperature. A temperature probe set to monitor battery temperature can also be used for the rectifier battery charge temperature compensation feature, or the battery charge temperature compensation feature can be programmed to use the average or highest value of all battery temperature probes. The battery charge temperature compensation feature allows the controller to automatically increase or decrease the output voltage of the system to maintain battery float current as battery temperature decreases or increases, respectively. Battery life can be extended when an optimum charge voltage to the battery with respect to temperature is maintained. A temperature probe set to monitor battery temperature can also be used for the BTRM (Battery Thermal Runaway Management) feature. The BTRM feature lowers output voltage when a high temperature condition exists to control against battery thermal runaway.
- ◆ The temperature sensor end of the probe contains a tab with a 5/16" clearance hole for mounting.
- ◆ Temperature probes can also be used with the optional [SM-Temp Temperature Concentrator](#).

Restrictions

A temperature probe programmed to monitor battery temperature should be mounted on the negative post of a battery cell to sense battery temperature. A temperature probe used for battery charge temperature compensation and/or BTRM (Battery Thermal Runaway Management) should also be mounted on the negative post of a battery cell. A temperature probe programmed to monitor ambient temperature should be mounted in a convenient location, away from direct sources of heat or cold.

Ordering Notes

- 1) Order temperature probes as required. Note that each temperature probe consists of two or three pieces which plug together to make a complete probe (see the following illustration). For a complete temperature probe, order one (1) P/N 552992 (10.3 meters) or one (1) P/N 556155 (3.3 meters). If additional length is required, order temperature probe extension cable P/N 04119122 (10 meters).
- 2) If more probes are desired, order one or more SM-Temp Temperature Concentrator, P/N 547490. See [Optional SM-Temp Temperature Concentrator](#) on page 33.

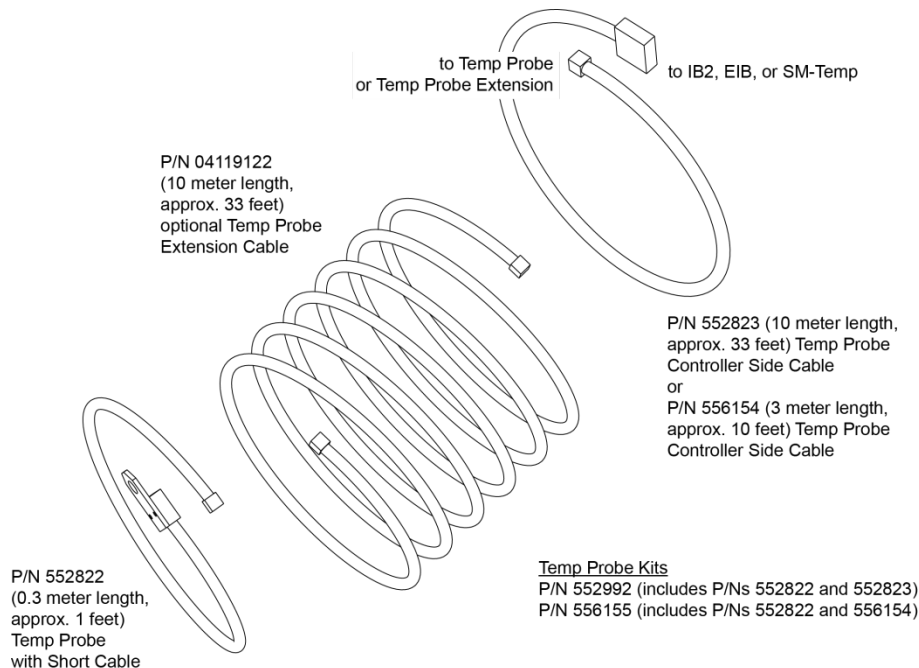

Optional SM-Temp Temperature Concentrator, P/N 547490

Features

- ◆ Allows for multiple temperature probes to be used for ambient temperature monitoring, battery temperature monitoring, temperature compensation, and/or BTRM (Battery Thermal Runaway Management).
- ◆ Provides (8) temperature probe inputs per SM-Temp.
- ◆ Can cascade up to (8) SM-Temp modules, connecting up to sixty-four (64) temperature probes.
- ◆ The SM-Temp Concentrator is connected at the end of the controller CAN bus. Via the CAN Bus, the controller reads each temperature probe from each SM-Temp Concentrator.

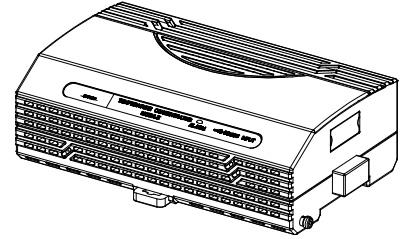

Restrictions

Requires ACU+ version 3.02 or later when SM-Temp is connected into the ACU+ CAN bus.

Ordering Notes

- 1) Order SM-Temp Temperature Concentrator, P/N 547490, as required.
- 2) Order up to (8) temperature probes for each concentrator. See “Optional Temperature Probes” on page 32.

Optional List 27 Critical Alarm Indicator, P/N 555877

Features

- ◆ Provides an alarm indicator visible from the front of a List 27 distribution cabinet which illuminates if the controller issues a critical alarm.

Restrictions

For use in List 27 only.

Ordering Notes

- 1) Order by P/N 555877 as required.

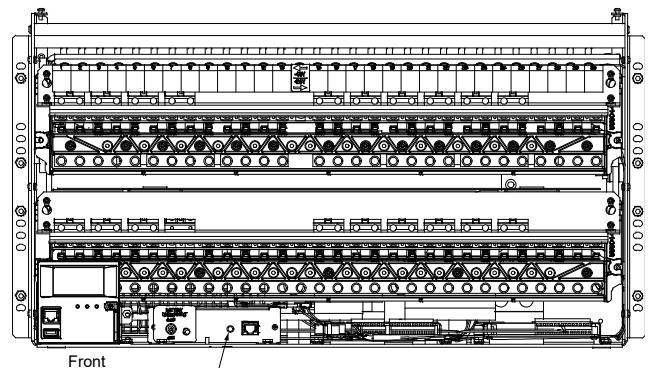

Rectifier Module

Rectifier Module, P/N 1R482000E3

Features

- ◆ Provides one (1) Model R48-2000e3, Spec. No. 1R482000E3, 2000 watt / -48 volt rectifier module.
- ◆ Refer to the Rectifier Instructions (UM1R482000E3) for more information.

Restrictions

For use in Spec. No. 588705300 module mounting shelf.

Ordering Notes

- 1) Order by P/N 1R482000E3 as required. Refer to [List 7](#) on page 9 and [List 27](#) on page 10 for quantity of rectifier and converter modules per system.

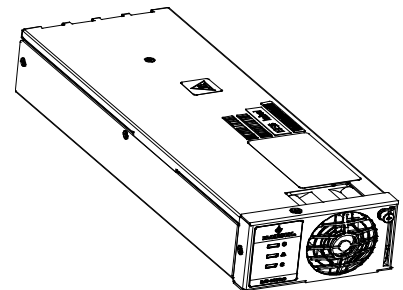

Converter Module

-48 VDC to +24 VDC Converter Module, P/N 1C48241500

Features

- ◆ Provides one (1) Model C48/24-1500, Spec. No. 1C48241500, 1500 watt / 48 to 24 volt DC-DC converter module.
- ◆ Refer to the Converter Instructions (UM1C48241500) for more information.

Restrictions

For use in Spec. No. 588705300 module mounting shelf.

Ordering Notes

- 1) Order by P/N 1C48241500 as required. Refer to [List 7](#) on page 9 and [List 27](#) on page 10 for quantity of rectifier and converter modules per system.

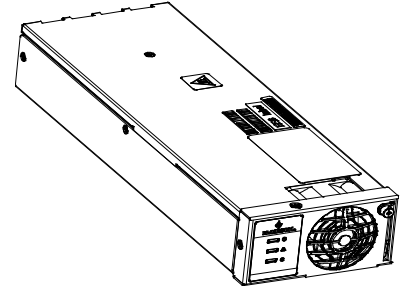

-48 VDC to -58 VDC Converter Module, P/N 1C48582000P3

Features

- ◆ Provides one (1) Model C48/58-2000P3, Spec. No. 1C48582000P3, 2000 watt / -48 V to -58 V converter module.
- ◆ Refer to the Converter Instructions (UM1C48582000P3) for more information.

Restrictions

For use in Spec. No. 588705300 module mounting shelf.

Ordering Notes

- 1) Order by P/N 1C48582000P3 as required. Refer [List 27](#) on page 10 for quantity of rectifier and converter modules per system.

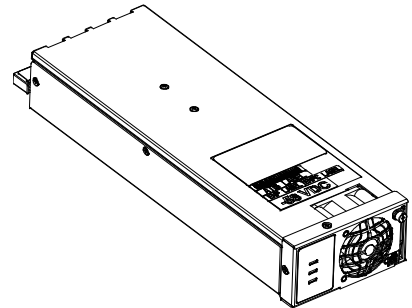

Optional eSure™ Power Extend Converter

Features

- ◆ The eSure Power Extend Converter (Model C48/58-1000B, Spec. No. 1C48581000B) is a compact DC/DC converter unit which offers efficient power conversion. It operates from a nominal -48 VDC source to provide regulated -58 VDC to the load for continuous operation to end of battery discharge. Refer to UM565050 and IM565460 for further information.

Restrictions

Only install the power extend converter into a -48 VDC distribution position. Non-repairable damage will occur if the power extend converter is plugged into a +24 VDC distribution position.

Requires a Power Extend Converter Mounting kit.

For use in 582137000 List 27 distribution cabinet only.

Ordering Notes

- 1) To add an eSure Power Extend Converter to a 582137000 List 27 power system; refer to the material list in the eSure Power Extend Converter Calculator (link provided below).

<https://www.vertiv.com/en-us/products-catalog/critical-power/dc-power-systems/esure-power-extend-converter-c4858-1000/#/downloads>

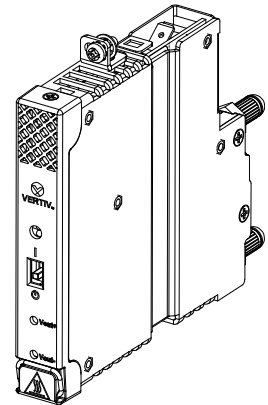

-48 VDC to -58 VDC Output Converter Upgrade Field Kit, Retrofit kit, P/N 60028248

Features

- ◆ This kit provides components to change converter module mounting positions for Spec. No. 1C48241500 (-48 VDC to +24 VDC) converter modules to mounting positions for Spec. No. 1C48582000P3 (-48 VDC to -58 VDC) converter modules. It also provides components to change the breaker positions in the distribution cabinet from +24 VDC to -58 VDC. A backout procedure is also provided.

Restrictions

Must be used with Spec. Nos. 582137000ZZ001 and 582137000ZZ007.

Must be used in top row only of the 2-row power system.

Requires an NCU Controller in the system to use the Spec. No. 1C48582000P3 (-48 VDC to -58 VDC) converter modules.

Ordering Notes

- 1) Order by P/N 60028248 as required.
- 2) Order optional DC-DC converter modules as required, P/N [1C48582000P3](#).

-58V, Busbar, Row 1, Field Kit, P/N 60031305

Features

- ◆ This kit provides components to convert the row 1 (bottom row) distribution panel to -58V positions.

Restrictions

Must be used with Spec. Nos. 582137000ZZ001 and 582137000ZZ007.

Requires an NCU controller in the system to use the Spec. No. 1C48582000P3 (-48 VDC to -58 VDC) converter modules.

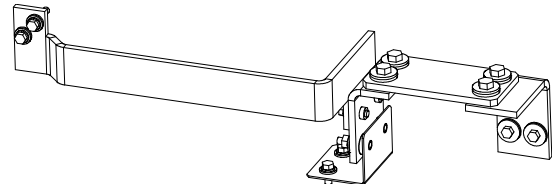

Ordering Notes

- 1) Order P/N 60028248 as required (see above).
- 2) Order by P/N 60031305 as required.
- 3) This kit will not work with a DC Generator input kit installed.

Distribution Devices

Bullet Nose Type Circuit Breakers and Bullet Nose Type Fuseholders e/w TPS/TLS Fuses

Features

- ◆ Each circuit breaker (as listed in Table 1 and Table 2) plugs into one, two, or three mounting position(s) on a distribution panel containing bullet nose type distribution positions.
- ◆ A single fuseholder provides for installation of a 3A to 100A Bussmann TPS type or Littelfuse TLS type fuse (as listed in Table 3). This fuseholder plugs into a single mounting position on a distribution panel containing bullet nose type distribution positions. This fuseholder provides a GMT-A alarm type fuse, which operates open to provide an alarm indication if the associated distribution fuse opens.

Restrictions

For use in Lists AC, BW, DH, DI, DJ, DK, DL, and FG, FH, FI, FJ, FK, FL, FM and GC.

Typically, loads should not exceed 80% of device rating.

In a 65°C environment, loads should not exceed 70% of device rating for 80A to 150A circuit breakers and 80A to 100A fuses.

In a 65°C environment, loads should not exceed 60% of device rating for 200A to 300A circuit breakers.

Install distribution devices from left to right, starting with the highest capacity and working to the lowest capacity.

Caution: *A circuit breaker or fuse with a rating of 80A or greater SHALL HAVE an empty mounting position between it and any other overcurrent protective device.*

Ordering Notes

- 1) Order circuit breakers as required per Table 1 or Table 2.
- 2) Order fuses as required per Table 3. For each fuse ordered, also order one (1) P/N 117201 bullet nose type fuseholder.
- 3) See Table 11 for recommended battery and load distribution wire sizes and lugs.
- 4) When ordering 125A to 200A circuit breakers, busbar adapter kit P/N 545404DCP may be ordered per circuit breaker. See Table 8. Other lug options are shown in Table 7.

Vertiv™ NetSure™ 512NGBB DC Power System

System Application Guide

- 5) When ordering 225A to 300A circuit breakers, busbar adapter kit P/N 545571DCP may be ordered per circuit breaker. See Table 8. Other lug options are shown in Table 7.

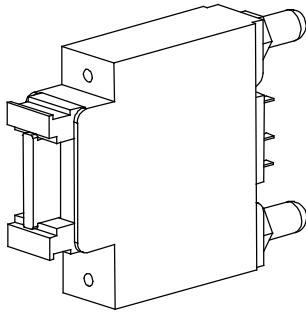

Bullet Nose Fuseholder

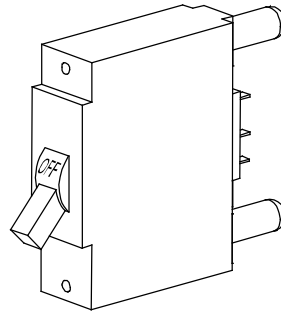

Toggle Handle
Bullet Nose Circuit Breaker

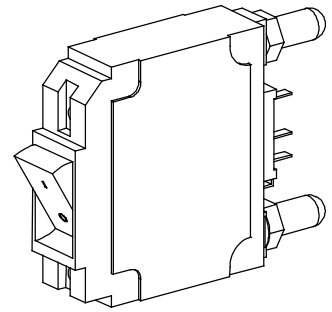

Rocker Handle
Bullet Nose Circuit Breaker

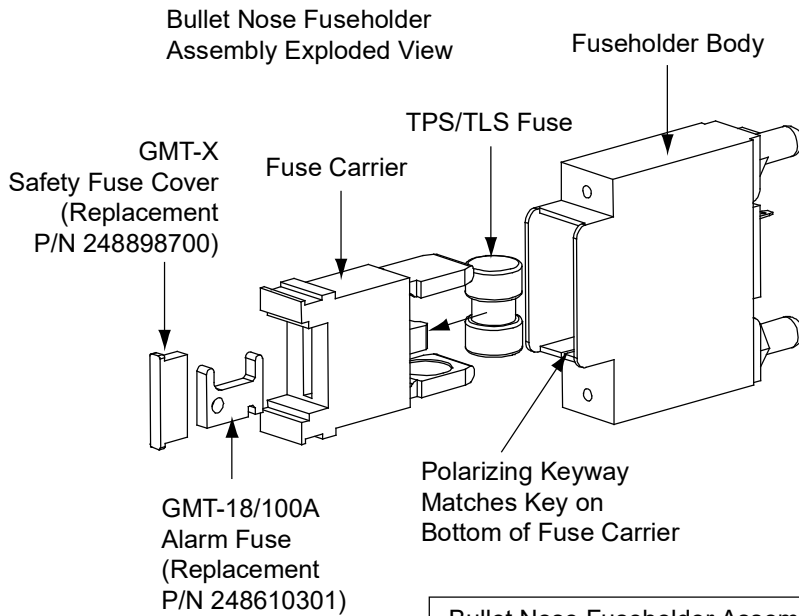

Bullet Nose Fuseholder Assembly (P/N 117201) includes body & carrier, alarm fuse, and alarm fuse safety cover.

Vertiv™ NetSure™ 512NGBB DC Power System
System Application Guide

Ampere Rating	Number of Poles	Number of Mounting Positions Required	Part Number	
			Electrical Trip ¹ (White Handle)	Electrical/ Mechanical Trip ² (Black Handle)
1	1	1	102272	101596
3	1	1	102273	101597
5	1	1	102274	101598
10	1	1	102275	101599
15	1	1	102276	101600
20	1	1	102277	101601
25	1	1	102278	101602
30	1	1	102279	101603
35	1	1	102280	101604
40	1	1	102281	101605
45	1	1	121998	121997
50	1	1	102282	101606
60	1	1	102283	101607
70	1	1	102284	101608
75	1	1	102285	101609
80	1	2	121996	121995
100	1	2	102286	101610
125	2	3	516991	516838
150	2	3	516993	516839
175	2	3	144883	144884
200	2	3	121831	121832
225	3	4	144885	144886
250	3	4	121835	121836
300	3	4	149075	149076
See Table 11 for recommended battery and load distribution wire sizes and lugs.				
When ordering 125A to 200A circuit breakers, busbar adapter kit P/N 545404DCP may be ordered per circuit breaker. See Table 8. Other lug options are shown in Table 7.				
When ordering 225A to 300A circuit breakers, busbar adapter kit P/N 545571DCP may be ordered per circuit breaker. See Table 8. Other lug options are shown in Table 7.				

Circuit Breaker Alarm Operation:

- ¹ Provides an alarm during an electrical trip condition only.
- ² Provides an alarm during an electrical or manual trip condition.

Note: Electrical Trip only circuit breakers are not typically used for battery disconnect circuit breakers.

Table 1
Toggle Handle Bullet Nose Type Circuit Breakers

Vertiv™ NetSure™ 512NGBB DC Power System
System Application Guide

Ampere Rating	Number of Poles	Number of Mounting Positions Required	Part Number	
			Electrical Trip ¹ (White Handle)	Electrical/ Mechanical Trip ² (Black Handle)
1	1	1	142856	142878
3	1	1	142857	142879
5	1	1	142858	142880
10	1	1	142859	142881
15	1	1	142861	142882
20	1	1	142862	142883
25	1	1	142863	142884
30	1	1	142864	142885
35	1	1	142865	142886
40	1	1	142866	142887
45	1	1	142867	142888
50	1	1	142868	142889
60	1	1	142869	142890
70	1	1	142870	142891
75	1	1	142871	142892
80	1	2	142872	142901
100	1	2	142873	142902
125	2	3	142874	142903
150	2	3	142875	142904
200	2	3	142876	142905
250	3	4	142877	142906
See Table 11 for recommended battery and load distribution wire sizes and lugs.				
When ordering 125A to 200A circuit breakers, busbar adapter kit P/N 545404DCP may be ordered per circuit breaker. See Table 8. Other lug options are shown in Table 7.				
When ordering 225A to 250A circuit breakers, busbar adapter kit P/N 545571DCP may be ordered per circuit breaker. See Table 8. Other lug options are shown in Table 7.				

Circuit Breaker Alarm Operation:

- ¹ Provides an alarm during an electrical trip condition only.
- ² Provides an alarm during an electrical or manual trip condition.

Note: *Electrical Trip only circuit breakers are not typically used for battery disconnect circuit breakers.*

Table 2
Rocker Handle Bullet Nose Circuit Breakers

Ampere Rating	Part Number	Bussmann P/N	Littelfuse P/N
3	248230900	TPS-3	TLS003
5	248231000	TPS-5	TLS005
6	248231200	TPS-6	TLS006
10	248231500	TPS-10	TLS010
15	248231800	TPS-15	TLS015
20	248232100	TPS-20	TLS020
25	248232400	TPS-25	TLS025
30	248232700	TPS-30	TLS030
40	248233300	TPS-40	TLS040
50	248233900	TPS-50	TLS050
60	248234200	TPS-60	TLS060
70	248234500	TPS-70	TLS070
80	118413	--	TLS080
90	118414	--	TLS090
100	118415	--	TLS100
Bullet Nose Type Fuseholder		P/N 117201 (Includes Fuseholder, 18/100A GMT-A Alarm Fuse, and GMT-X Safety Fuse Cover)	
See Table 11 for recommended battery and load distribution wire sizes and lugs.			

Table 3
Bullet Nose Type Fuseholders and TPS/TLS Fuses

Bullet Nose Bypass Busbar, P/N 535015

Features

- ◆ Replaces a bullet nose circuit breaker or fuseholder when a protective or disconnect device is not required.

Ordering Notes

- 1) Order by P/N 535015 as required.

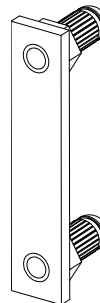

Vertiv™ NetSure™ 512NGBB DC Power System

System Application Guide

Optional Bullet Nose Type 6-Position GMT Distribution Fuse Block, P/N 549017

Features

- ◆ Provides six (6) load distribution fuse positions (1/4A to 15A GMT alarm-type fuses).
- ◆ Single voltage distribution (-48V or +24V or -58V).
- ◆ Mounts in two (2) distribution positions of any “bullet nose” distribution panel.
- ◆ Screw clamp type load and load return terminals provided.
- ◆ Includes six (6) dummy fuses equipped with safety fuse covers.

Restrictions

For use in a List 27 distribution cabinet.

Can only be installed in the 1-2, 3-4, 5-6, 7-8, 15-16, 17-18, 19-20, 21-22, 23-24, and 25-26 positions of the distribution panel.

Occupies two (2) bullet device mounting positions.

Terminal block wire size capacity is 26 to 14 AWG.

Maximum total current is 21.4A.

Maximum fuse size @ +65°C is 15A.

When used for power distribution, load should not exceed 80% of device rating, except 10 amp fuses for which load should not exceed 70% of device rating and 15 amp fuses for which load should not exceed 50% of device rating.

Caution: *At 65°C ambient, GMT fuses greater than 5A SHALL have an empty mounting position between it and any other fuse.*

Ordering Notes

- 1) Order optional Bullet Nose Type 6-Position GMT Fuse Block (P/N 549017) as required for a List 27 distribution cabinet. Provides one alarm fuse distribution assembly, ground return link, and hardware.
- 2) Order fuses as required per Table 4.

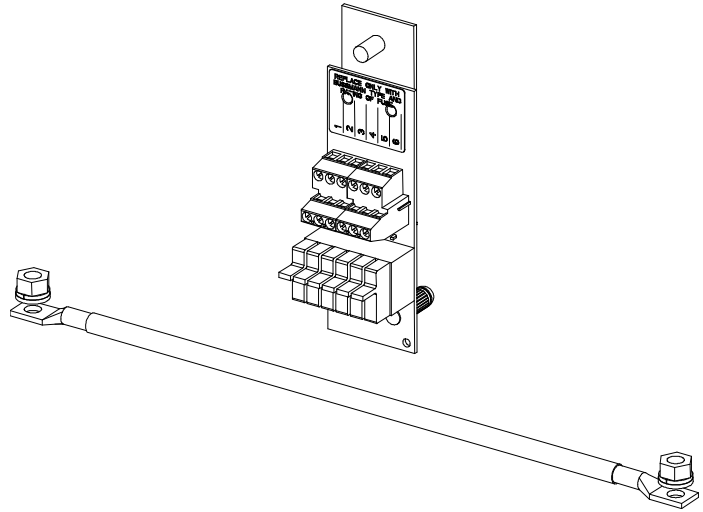

Vertiv™ NetSure™ 512NGBB DC Power System

System Application Guide

Optional Bullet Nose Type 6-Position GMT Distribution Fuse Block, P/N 545333DCP

Features

- ◆ Provides six (6) load distribution fuse positions (1/4A to 15A GMT alarm-type fuses).
- ◆ Single voltage distribution (-48V or +24V).
- ◆ Mounts in two (2) distribution positions of any “bullet nose” distribution panel.
- ◆ Screw clamp type load and load return terminals provided.
- ◆ Includes six (6) dummy fuses equipped with safety fuse covers.

Restrictions

For use in a List 7 distribution cabinet.

CANNOT be installed in the 6, 7, 8, and 9 positions of the distribution panel.

Occupies two (2) bullet device mounting positions.

Terminal block wire size capacity is 26 to 14 AWG.

Maximum total current is 30A.

Maximum fuse size @ +65°C is 15A.

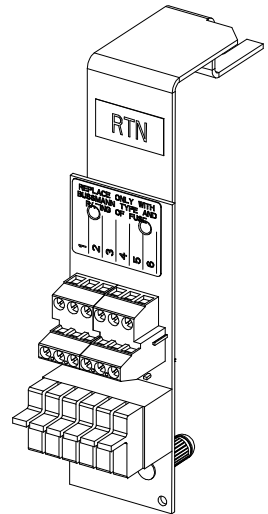

Caution: 15A GMT fuses *SHALL* have an empty mounting position between it and any other fuse.

Ordering Notes

- 1) Order optional Bullet Nose Type 6-Position GMT Fuse Block (P/N 545333DCP) as required for a List 7 distribution cabinet. Provides one alarm fuse distribution assembly, ground return link, and hardware.
- 2) Order fuses as required per Table 4.

Vertiv™ NetSure™ 512NGBB DC Power System

System Application Guide

GMT Type Load Distribution Fuses

Features

- ◆ An optional “Bullet Nose Type 6-Position GMT Distribution Fuse Block, P/N 549017 or P/N 545333DCP” is available for additional load distribution.

Ordering Notes

- 1) Order fuses as required per Table 4.

Ampere Rating	Part Number	Fuse Color
18/100 (GMT-A)	248610301	---
1/4	248610200	Violet
1/2	248610300	Red
3/4	248610500	Brown
1-1/3	248610700	White
2	248610800	Orange
3	248610900	Blue
5	248611000	Green
7-1/2	248611300	Black-White
10	248611200	Red-White
15	248611500	Red-Blue
Replacement Safety Fuse Cover (GMT-Y)	102774	---
Replacement Dummy Fuse	248872600	---

Table 4
GMT Fuses

Transient Voltage Surge Suppressor (TVSS) Device, P/N 122201 (Kit P/N 520401)

Features

- ◆ When properly grounded, the device(s) suppresses transient voltages that are above 60 VDC.
- ◆ Contains an indicator which lights when circuit has activated to suppress voltages.
- ◆ Mounts in two (2) distribution positions of any “bullet nose” -48V or -58V distribution panel.

Restrictions

The Transient Voltage Surge Suppressor (TVSS) device is to be installed on the -48V or -58V distribution bus only.

All unparalleled distribution panels require a TVSS Device, only one (1) TVSS Device required per paralleled groups of distribution panels.

Unless otherwise specified, install the TVSS Device in the mounting position closest to the distribution panel’s input busbar.

Wire to be sized so that the maximum wire resistance is less than 0.550 milliohms.

Caution: *The TVSS Device occupies two mounting positions. Leave an additional empty mounting position between the TVSS Device and any overcurrent protective device.*

Ordering Notes

- 1) Order kit P/N 520401 (includes TVSS Device P/N 122201 plus lug mounting hardware) as required. Customer to supply grounding lead(s) with lugs to connect from TVSS Device(s) into customer’s grounding network.

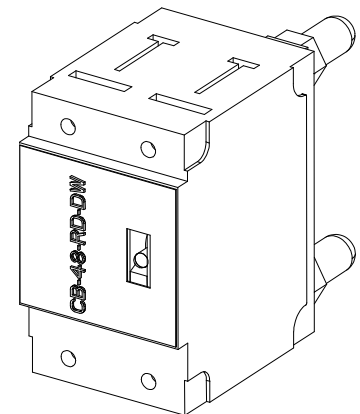

Standard Crimp Lugs, Special Application Crimp Lugs, and Busbar Adapter Kits and Hardware Kits

Standard Crimp Lug Tables

Lead Size	Part Number
14-10 AWG	245342300
8 AWG	245390200
6 AWG	245346700
4 AWG	245346800
2 AWG	245346900

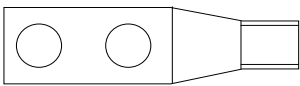

Table 5
Crimp Lug
Two-Hole, 1/4" Bolt Clearance Hole, 5/8" Centers

Lead Size	Part Number
6 AWG	245349900
4 AWG	245350000
2 AWG	245348200
1/0 AWG	245347100
2/0 AWG	245347200
3/0 AWG	245347300
4/0 AWG	245347400
250 kcmil	245347500
300 kcmil	245347600
350 kcmil	245347700
400 kcmil	245347800
500 kcmil	245347900
600 kcmil	245348000
750 kcmil	245348100

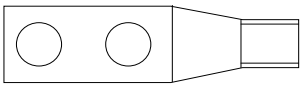

Table 6
Crimp Lug
Two-Hole, 3/8" Bolt Clearance Hole, 1" Centers

Vertiv™ NetSure™ 512NGBB DC Power System

System Application Guide

Special Application Crimp Lug / Strap Combination Table

Features

- ◆ Straps two fuseholder/circuit breaker wiring positions together, and provides a crimp-type lug which allows distribution wiring up to 350 kcmil size (maximum size of wire to be connected to a single position is 2 AWG). Designed for use with 125A and larger bullet nose-type circuit breakers or TPS/TLS-type fuses, which require at least two mounting positions.

Restrictions

If used with bullet nose-type circuit breakers or TPS/TLS-type fuses smaller than 125A, an empty mounting position is required adjacent to the distribution device.

Ordering Notes

- 1) Specify part number from Table 7 for desired lead size.
Refer also to “Busbar Adapter and Hardware Kits” on page 45 for other lug options.

Lead Size	Part Number	
1/0 AWG	245393500	
2/0 AWG	245393600	
3/0 AWG	245393700	
4/0 AWG	245393800	
250 kcmil	514872	
350 kcmil	514873	

Table 7
Special Application Crimp Lug / Strap Combination
(Two-Hole Lug, 1/4" Bolt Clearance Hole, 5/8" Centers)

Vertiv™ NetSure™ 512NGBB DC Power System

System Application Guide

Busbar Adapter and Hardware Kits

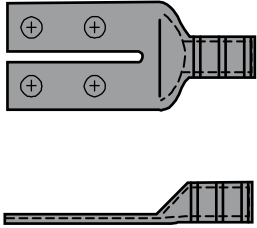
Features

- ◆ See Table 8 for part numbers and descriptions of available kits.
- ◆ Kits include hardware shown.
- ◆ Unless otherwise specified, busbar adapter kits are factory-installed when ordered with system.

Part Number	Description
545404DCP	Busbar Adapter Kit – Converts two (2) load positions (1/4-20 on 5/8" centers) to one (1) landing (3/8-16 on 1" centers). Right angle load busbar and straight return busbar for rear wiring egress.
545405DCP	Busbar Adapter Kit – Converts one (1) load position (1/4-20 on 5/8" centers) to one (1) load landing (1/4-20 on 5/8" centers), right angle.
545571DCP	Busbar Adapter Kit – Converts three (3) load positions (1/4-20 on 5/8" centers) to one (1) landing (3/8-16 on 1" centers). Right angle load busbar and straight return busbar for rear wiring egress.
545412DCP	Lug Hardware kit – (4) 1/4-20 nuts, lock washers, and flat washers.

545404DCP 545405DCP 545571DCP

545412DCP

Table 8
Busbar Adapter and Hardware Kits

AC Input Cable Assemblies

AC Input Cable Assembly, P/N 535232

Features

- ◆ Provides one (1) 30" long, 8 AWG, AC input cable assembly that is terminated on one end with a Molex plug which mates with AC input receptacle on the module mounting shelf, and not terminated on the remaining end.

Restrictions

For use with module mounting shelves with plug-in AC input connectors (i.e. List 31 field expansion module mounting shelf in a system with a List 27 distribution cabinet or if List 7 distribution cabinet system is used in a relay rack and not a system cabinet).

Rated for 30A.

Ordering Notes

- 1) Order AC input cable assemblies as required. Each 588705300 module mounting shelf equipped with rear plug-in AC input connectors requires three (3) AC input cable assemblies. Each input feeds two rectifiers.

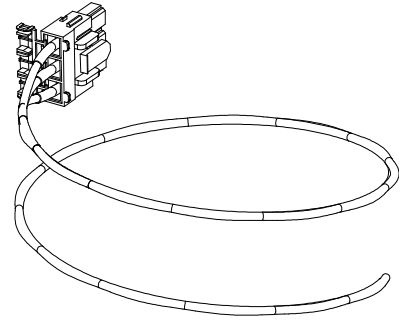

AC Input Cable Assembly, P/N 547898

Features

- ◆ Provides one (1) 6' long, 8 AWG, AC input cable assembly that is terminated on one end with a Molex plug which mates with AC input receptacle on the module mounting shelf, and not terminated on the remaining end.

Restrictions

For use with module mounting shelves with plug-in AC input connectors (i.e. List 31 field expansion module mounting shelf in a system with a List 27 distribution cabinet or if List 7 distribution cabinet system is used in a relay rack and not a system cabinet).

Rated for 30A.

Ordering Notes

- 1) Order AC input cable assemblies as required. Each 588705300 module mounting shelf equipped with rear plug-in AC input connectors requires three (3) AC input cable assemblies. Each input feeds two rectifiers.

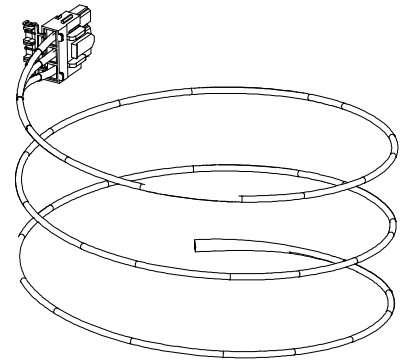

AC Input Wiring Kit, P/N 557836

Features

- ◆ Provides factory installed AC input wiring for a 588705300 List 12 module mounting shelf in a system with a List 7 distribution cabinet.

Restrictions

For use with a 588705300 List 12 module mounting shelf in a system with a List 7 distribution cabinet.

This kit is factory installed in the shelf.

With this kit, only four (4) rectifier modules can be installed in the shelf.

Ordering Notes

- 1) Order AC input wiring kit as required. This kit provides unterminated 10 AWG leads for two (2) AC input feeds to the shelf. First AC input feeds rectifier mounting positions #1 and #2. Second AC input feeds rectifier mounting positions #3 and #4.

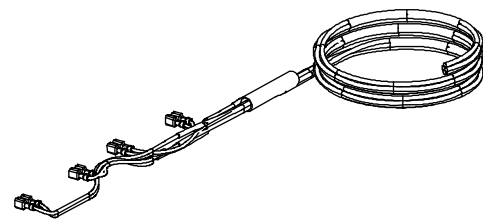

Generator Input Circuit Breaker Kit P/N 564898

Kit P/N 564898 is available for use with 582137000ZZ001, 582137000ZZ007, 582137000500 and 582137000501 power systems. This kit provides the components to install a 400 A circuit breaker to feed the rectifier output bus of the power system through a shunt. A customer connects an external generator output to this circuit breaker which then supplies generator input power to the system. For field installation, refer to IM564994. For wiring a generator to the circuit breaker, refer to Figure 1.

Load should not exceed 80% of the 400 A breaker rating (320 A).

Designed to accommodate two cables (per polarity), minimum wire ampacity is equivalent to one (1) 500 kcmil cable (each polarity).

Maximum lug width is 1.25".

Apply electrical anti-oxidation compound to busbar mating surfaces.

Components removed in illustration for clarity only.

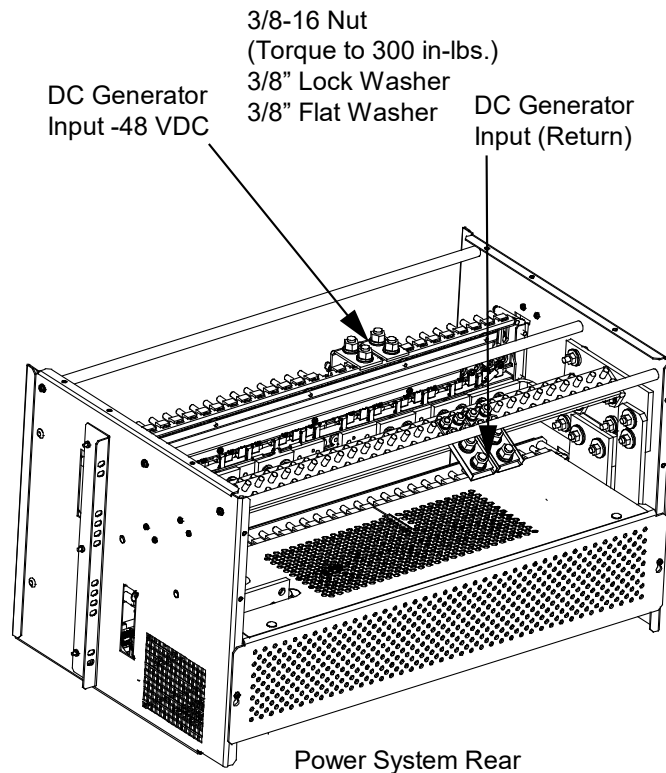

Figure 1
Wiring Input Generator Kit P/N 564898

User Replaceable Alarm, Reference, and Control Fuses

Ordering Notes

- Order replacement alarm fuses as required per Table 9.

Assembly	Desig.	Function	Size (Amperes)	Type	Part No.
TPS/TLS Fuseholders (P/N 117201)	FA	Fuse Alarm	18/100	Bussmann GMT-A	248610301
	--	--	--	Safety Fuse Cover (GMT-X)	248898700

Table 9
Replaceable Alarm, Reference, and Control Fuses

User Replaceable Components

Ordering Notes

- Refer to the following table.

Item	Part Number	
Rectifier Module	1R482000E3	
Converter Module	1C48241500	
Converter Module	1C48582000P3	
NCU Controller (in a 588705300 List 12)	1M830BNA	
NCU Controller (in a 582137000 List 27)	1M830DNA	
IB2 Controller Interface Board (in a 582137000 List 7)	MA4C5U31	
IB2 Controller Interface Board Assembly (in a 582137000 List 27)	555286 (Assembly) MA4C5U31 (Board Only)	
EIB Controller Extended Interface Board (in a 582137000 List 7)	MA455U41	
EIB Controller Extended Interface Board Assembly (in a 582137000 List 27)	548120 (Assembly) MA455U41 (Board Only)	
System Interface Board (in a 582137000 List 27)	555484	
Manual Battery Disconnect Circuit Card (in a 582137000 List 27)	540973	
SPD (Surge Protection Device) Replacement Plug-in Module (Replacement module for SPD P/N 10034885. Each SPD P/N 10034885 has two P/N 10035033 replacement modules. Both modules should be replaced at the same time.)	10035033	
SPD (Surge Protection Device) Replacement Assembly (includes SPD mounting base with two installed P/N 10035033 SPD plug-in modules.)	10034885	

Table 10
Replaceable Assemblies

RECOMMENDED WIRE SIZES, BRANCH CIRCUIT PROTECTION, CRIMP LUGS, AND WIRING ILLUSTRATIONS

Relay Rack / Cabinet Frame Grounding Requirements

For relay rack / cabinet grounding requirements, refer to the current edition of the American National Standards Institute (ANSI) approved National Fire Protection Association's (NFPA) National Electrical Code (NEC), applicable local codes, and your specific site requirements.

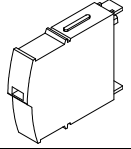
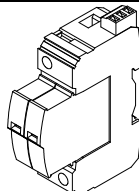
Central Office Grounding Connection

Landing points are provided on the battery return bus for a central office ground lead (see Figure 11 or Figure 12). For central office grounding requirements, refer to the current edition of the American National Standards Institute (ANSI) approved National Fire Protection Association's (NFPA) National Electrical Code (NEC), applicable local codes, and your specific site requirements.

AC Input and AC Input Equipment Grounding Connections to 588705300 Module Mounting Shelf(s)

There are several options to provide AC inputs to the 588705300 module mounting shelf. See PD588705300.

- 1) For factory installed module mounting shelves without plug-in AC input connectors, AC input leads are factory connected from the module mounting shelf AC input terminals to an AC input termination assembly provided in the system/cabinet. Refer to the system/cabinet documentation for connection details to the AC input termination assembly. Refer to the system/cabinet documentation for recommended AC input branch circuit protection.
- 2) For a field installed module mounting shelf in a system with a List 27 distribution cabinet or if a List 7 distribution cabinet is used in a relay rack and not a system cabinet, the module mounting shelf is equipped with plug-in AC input connectors located on the rear of the shelf. Order mating connectors and wire harnesses as required per "[AC Input Cable Assemblies](#)" on page 46. Refer to Power Data Sheet PD588705300 for recommended AC input branch circuit protection.

External Alarm, Reference, Monitoring, and Control Connections

General

Recommended wire size is 22 AWG for loop lengths up to 200 ft. and 18-20 AWG for loop lengths over 200 ft.

582137000 List 7 Distribution Cabinet

Refer to Figure 2.

582137000 List 27 Distribution Cabinet

Refer to Figure 3 and Figure 4.

IB2 (Controller Interface Board)

Refer to Figure 5.

EIB (Controller Extended Interface Board)

Refer to Figure 6.

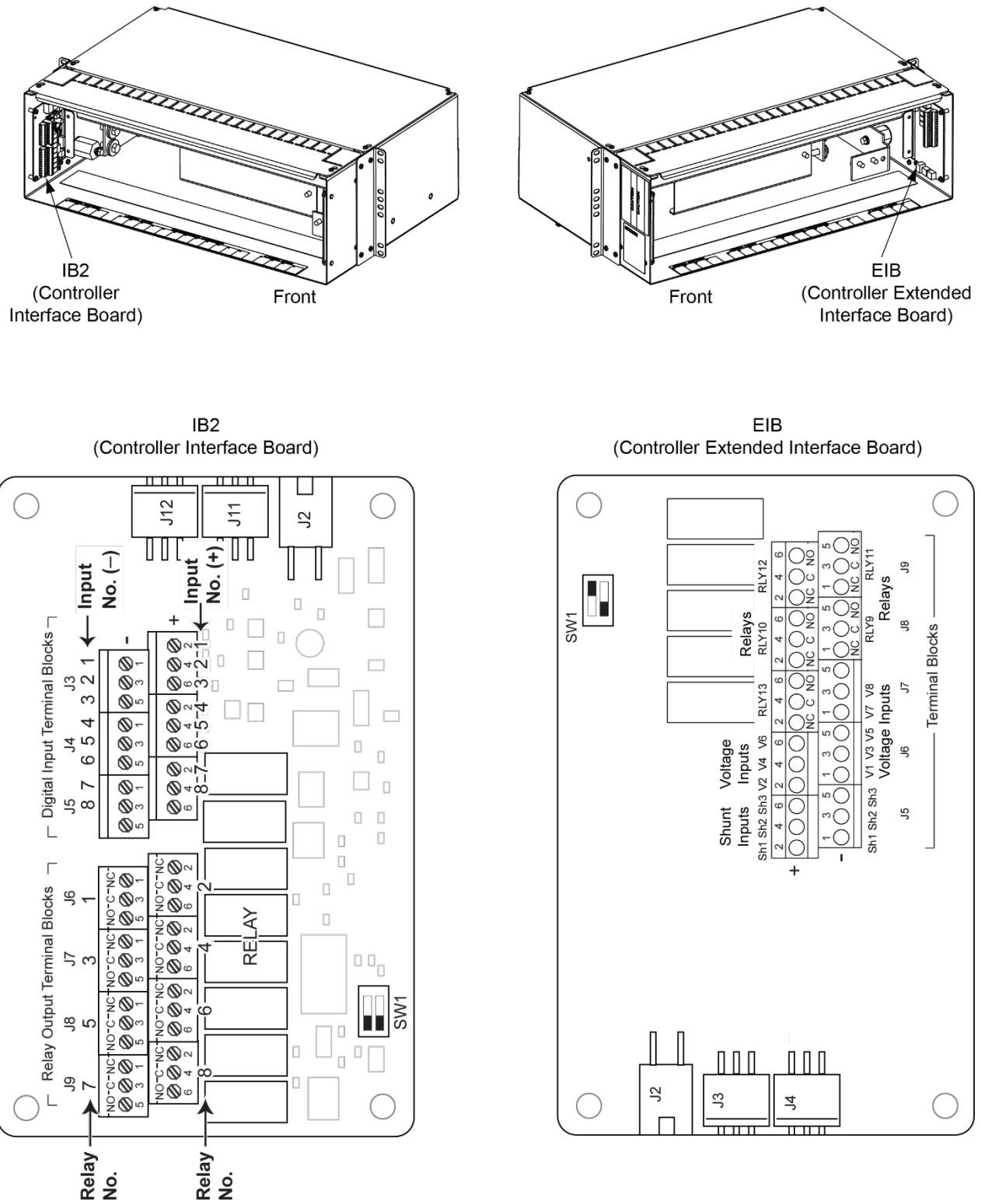

Figure 2
External Alarm, Reference, Monitoring, and Control Connections Locations
in a 582137000 List 7 Distribution Cabinet

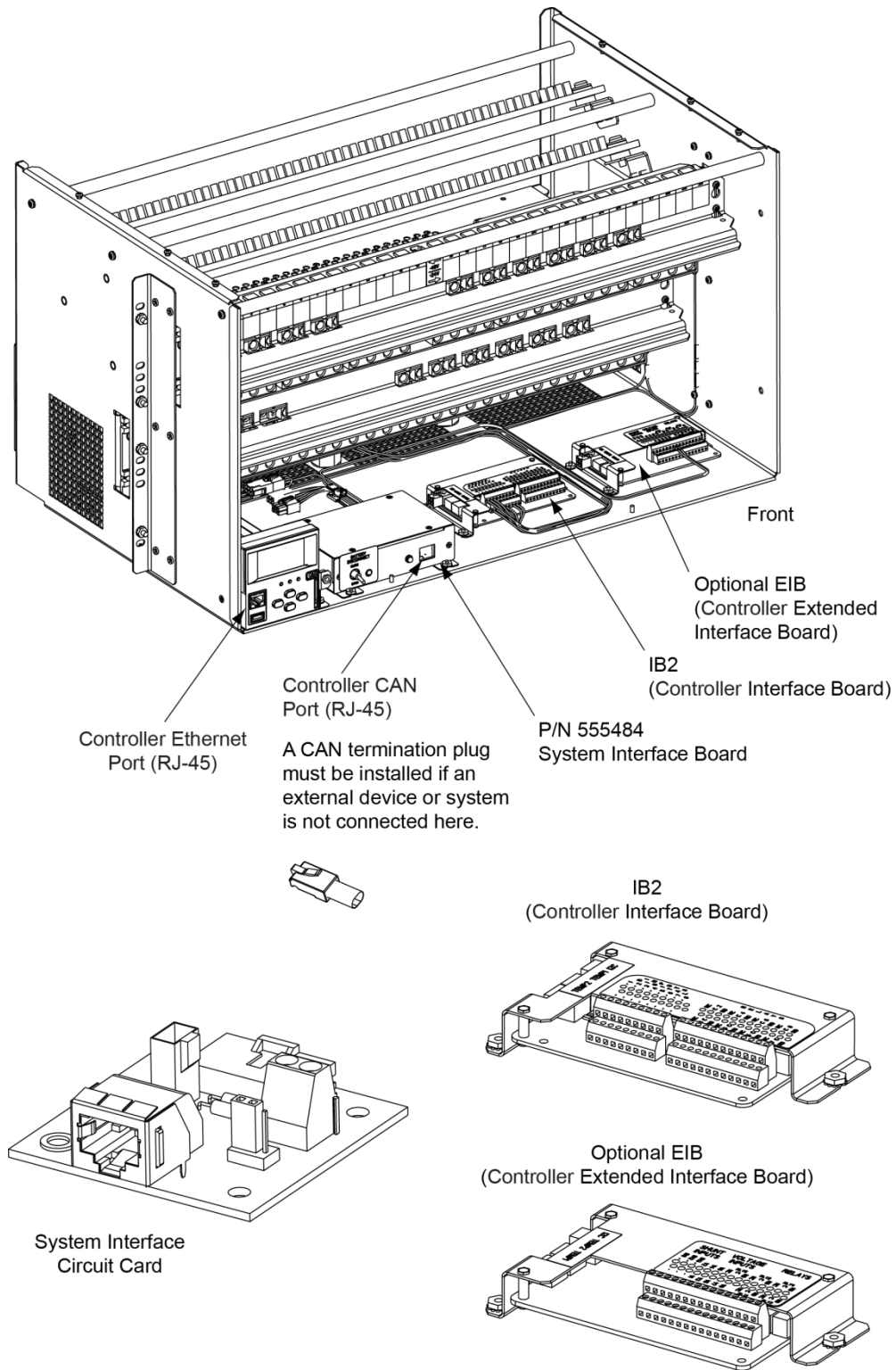
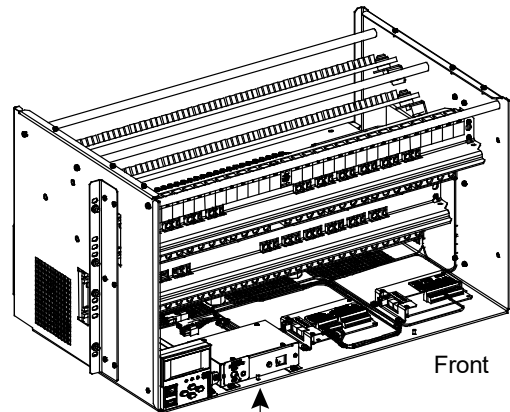
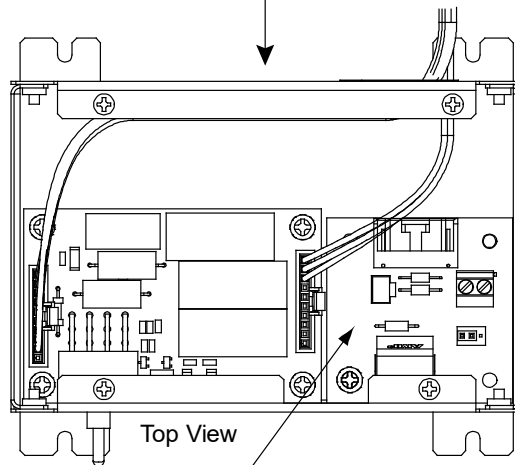

Figure 3
 External Alarm, Reference, Monitoring, and Control Connections Locations
 in a 582137000 List 27 Distribution Cabinet



Front



Top View

System Interface Board

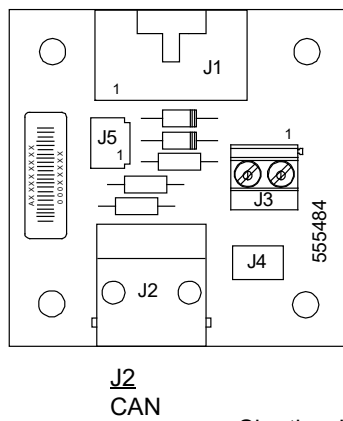

J3 on System Interface Board

RS485 Connection

J3-1: RS485+

J3-2: RS485-

J4 on System Interface Board

Selects to power Controller from “Battery Power” or not.

No		
Battery	Battery	
Pwr	Pwr	



Shorting Jumper

Figure 4

External Alarm, Reference, Monitoring, and Control Connections Locations, System Interface Board in a 582137000 List 27 Distribution Cabinet

Vertiv™ NetSure™ 512NGBB DC Power System

System Application Guide

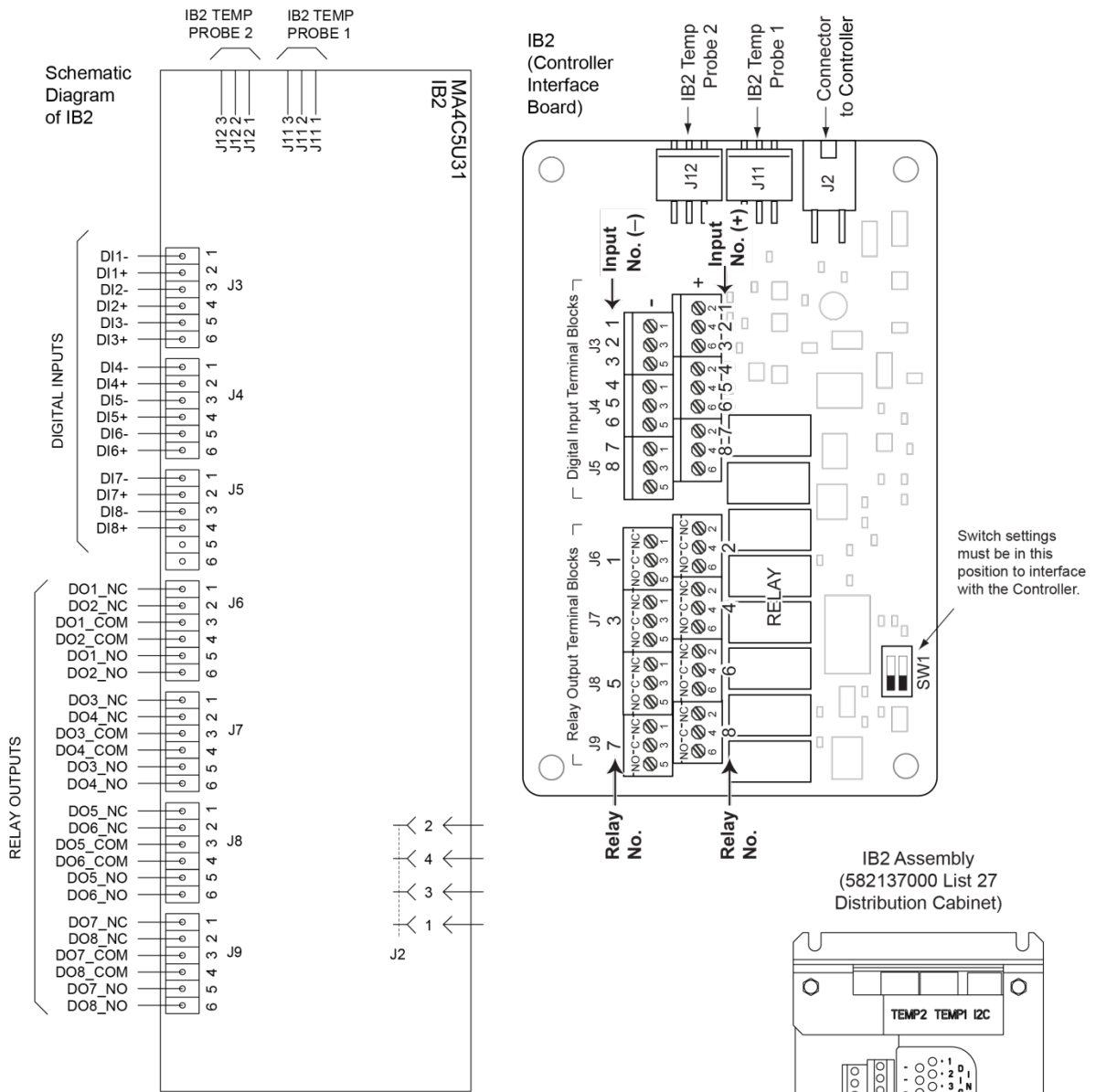

* The controller relay assigned to "Critical Summary" alarm (relay 1 by default) will operate in the "Fail Safe Mode". "Fail Safe Mode" means Relay 1 is de-energized during an alarm condition, opening the contacts between the C and NO terminals, and closing the contacts between the C and NC terminals.

The controller's remaining seven (7) relays energize during an alarm condition, closing the contacts between the C and NO terminals, and opening the contacts between the C and NC terminals.

Not all I/O points are available for customer connection (some are used for factory system connections).

J3-J9:

Wire Size Capacity: 16-26 AWG.
Recommended Torque: 2.2 in-lbs.

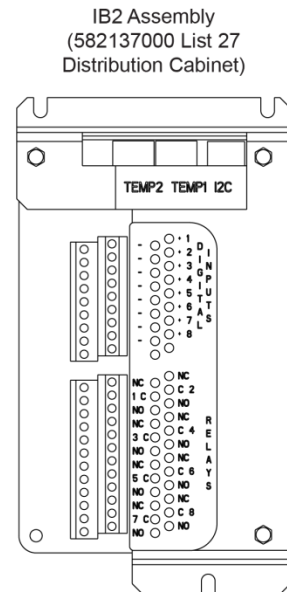

Figure 5
External Alarm, Reference, Monitoring, and Control Connections, IB2 (Controller Interface Board)

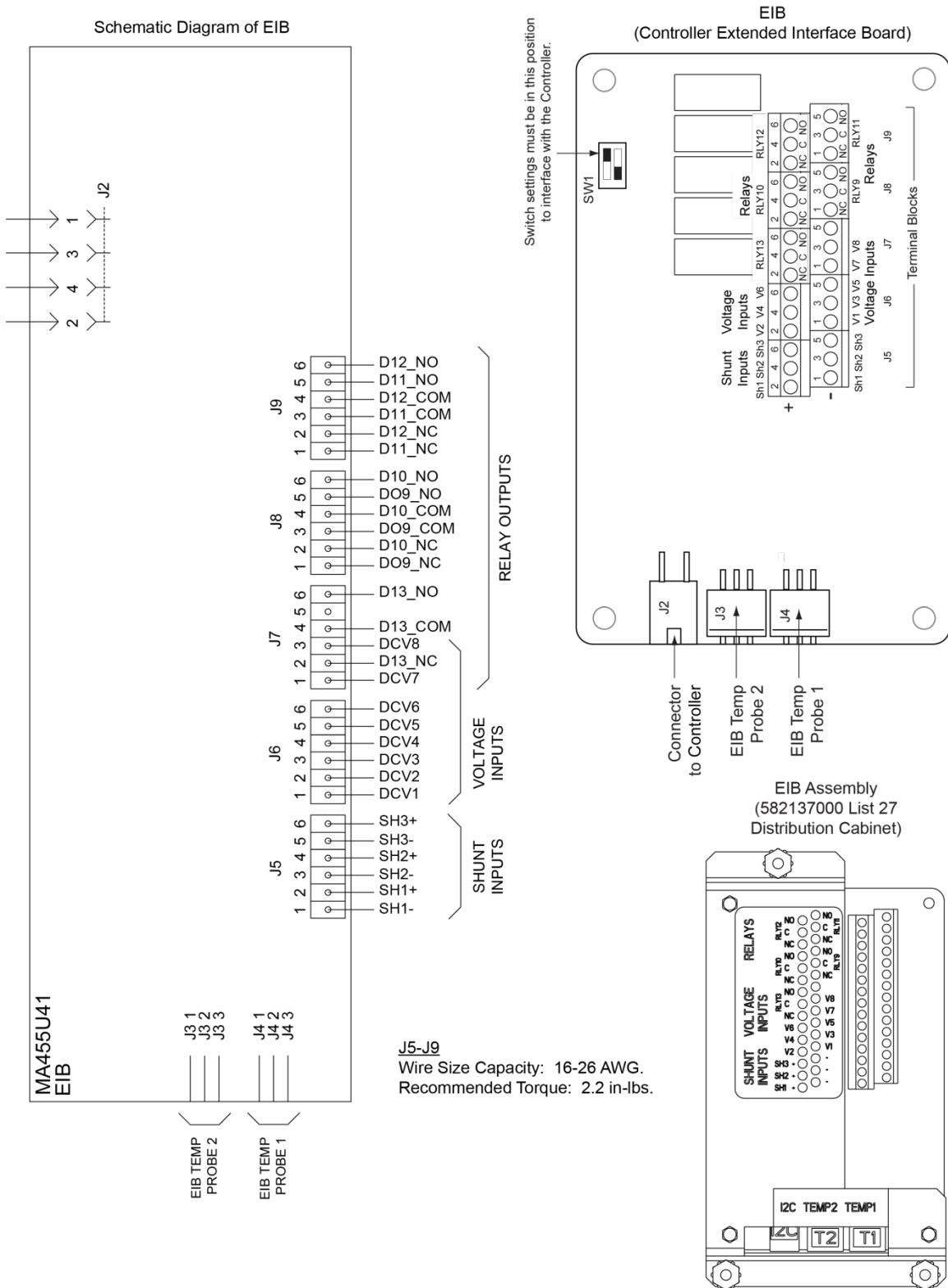

Figure 6
External Alarm, Reference, Monitoring, and Control Connections, EIB (Controller Extended Interface Board)

Load Distribution Connections

General

Load leads are connected to the individual load busbars located on the distribution panels. Load return leads are connected to the return busbar(s) located at the top of the distribution cabinet. These busbars provide 1/4-20 studs for installation of customer-provided two-hole lugs that have 5/8 inch centers and 1/4 inch bolt clearance holes. Customer must provide (or order) lug mounting hardware.

Maximum size of wire to be connected to a single fuseholder/circuit breaker position is 2 AWG. Refer to Table 5 for available lugs. For wiring up to 350 kcmil, see “Special Application Crimp Lug / Strap Combination” in Table 7. Refer also to “Busbar Adapter and Hardware Kits” in Table 8 for other lug options. Lugs should be crimped per lug manufacturer’s specifications.

The rating of the distribution device determines the load lead wire size requirement. Table 11 can be used to select recommended load distribution wire sizes and lugs for various loop lengths per fuse/circuit breaker ampere rating.

582137000 List 7 Distribution Cabinet

Refer to Figure 7.

582137000 List 27 Distribution Cabinet

Refer to Figure 8 and Figure 9.

GMT Fuse Block

Refer to Figure 10.

Vertiv™ NetSure™ 512NGBB DC Power System
System Application Guide

Fuse/Circuit Breaker Amperage	Recm 90°C Wire Size ⁽¹⁾						
	14 AWG	12 AWG	10 AWG	8 AWG	6 AWG	4 AWG	2 AWG
	Loop Length (feet) ⁽²⁾						
1, 3, 5, 6, 10A	37 ^(3, 4, 5)	58 ^(3, 4, 5)	93 ^(3, 4, 5)	148 ^(3, 4, 5)	236 ^(3, 4, 5)	376 ^(3, 4, 5)	597 ^(3, 4, 5)
15A	24 ^(3, 4)	39 ^(3, 4, 5)	62 ^(3, 4, 5)	99 ^(3, 4, 5)	157 ^(3, 4, 5)	250 ^(3, 4, 5)	398 ^(3, 4, 5)
20A	--	29 ^(3, 4)	46 ^(3, 4, 5)	74 ^(3, 4, 5)	118 ^(3, 4, 5)	188 ^(3, 4, 5)	298 ^(3, 4, 5)
25A	--	--	37 ^(3, 4)	59 ^(3, 4, 5)	94 ^(3, 4, 5)	150 ^(3, 4, 5)	239 ^(3, 4, 5)
30A	--	--	31 ^(3, 4)	49 ^(3, 4, 5)	78 ^(3, 4, 5)	125 ^(3, 4, 5)	199 ^(3, 4, 5)
35A	--	--	--	42 ^(3, 4)	67 ^(3, 4, 5)	107 ^(3, 4, 5)	170 ^(3, 4, 5)
40A	--	--	--	37 ^(3, 4)	59 ^(3, 4, 5)	94 ^(3, 4, 5)	149 ^(3, 4, 5)
45A	--	--	--	33 ^(3, 4)	52 ^(3, 4)	83 ^(3, 4)	132 ^(3, 4)
50A	--	--	--	29 ⁽³⁾	47 ^(3, 4)	75 ^(3, 4)	119 ^(3, 4)
60A	--	--	--	--	39 ^(3, 4)	62 ^(3, 4)	99 ^(3, 4)
70A	--	--	--	--	--	53 ^(3, 4)	85 ^(3, 4)
75A	--	--	--	--	--	50 ^(3, 4)	79 ^(3, 4)
80A	--	--	--	--	--	47 ⁽³⁾	74 ^(3, 4)
Recommended Crimp Lug ⁽⁶⁾							
Lug	245342300	245342300	245342300	245390200	245346700	245346800	245346900

Fuse/Circuit Breaker Amperage	Recm 90°C Wire Size ⁽¹⁾						
	2 AWG	1/0 AWG	2/0 AWG	3/0 AWG	4/0 AWG	250 kcmil	350 kcmil
	Loop Length (feet) ⁽²⁾						
90A	66 ^(3, 4)	105 ⁽³⁾	133 ⁽³⁾	--	--	--	--
100A	59 ^(3, 4)	95 ⁽³⁾	119 ⁽³⁾	--	--	--	--
125A	47 ⁽³⁾	76 ⁽³⁾	95 ⁽³⁾	120 ⁽³⁾	--	--	--
150A	--	63 ⁽³⁾	79 ⁽³⁾	100 ⁽³⁾	--	--	--
200A	--	--	--	75 ⁽³⁾	95 ⁽³⁾	112 ⁽³⁾	--
250A	--	--	--	--	76 ^(3, 8)	90 ^(3, 8)	126 ^(3, 8)
Recommended Crimp Lug							
Lug	245346900 ⁽⁶⁾	245393500 ⁽⁷⁾	245393600 ⁽⁷⁾	245393700 ⁽⁷⁾	245393800 ⁽⁷⁾	514872 ⁽⁷⁾	514873 ⁽⁷⁾

Table 11 (cont'd on next page)
Recommended Battery and Load Distribution Wire Size and Lug Selection
for TLS/TPS Fuse and Bullet Nose-Type Circuit Breaker

Notes to Table 11:

- ¹ Wire sizes are based on recommendations of the American National Standards Institute (ANSI) approved National Fire Protection Association's (NFPA) National Electrical Code (NEC). **Table 310-16** for wire rated at **90°C** conductor temperature operating in ambient temperatures of **40°C, 50°C, and 65°C** was used. For other operating ambient temperatures, refer to the NEC. For operation in countries where the NEC is not recognized, follow applicable codes.
- ² Recommended wire sizes are sufficient to restrict voltage drop to 1.0 volt or less at listed branch current for the loop lengths shown. Loop length is the sum of the lengths of the positive and negative leads.
- ³ Wire Size / Loop Length Combination Calculated using 40°C Ambient Operating Temperature.
- ⁴ Wire Size / Loop Length Combination Calculated using 50°C Ambient Operating Temperature.
- ⁵ Wire Size / Loop Length Combination Calculated using 65°C Ambient Operating Temperature.
- ⁶ These lugs are two-hole for 1/4" bolt clearance on 5/8" centers. Lugs should be crimped per lug manufacturer's specifications.
- ⁷ Special application crimp lug / strap combination.

Table 11 (cont'd from previous page)
Recommended Battery and Load Distribution Wire Size and Lug Selection
for TLS/TPS Fuse and Bullet Nose-Type Circuit Breaker

Vertiv™ NetSure™ 512NGBB DC Power System

System Application Guide

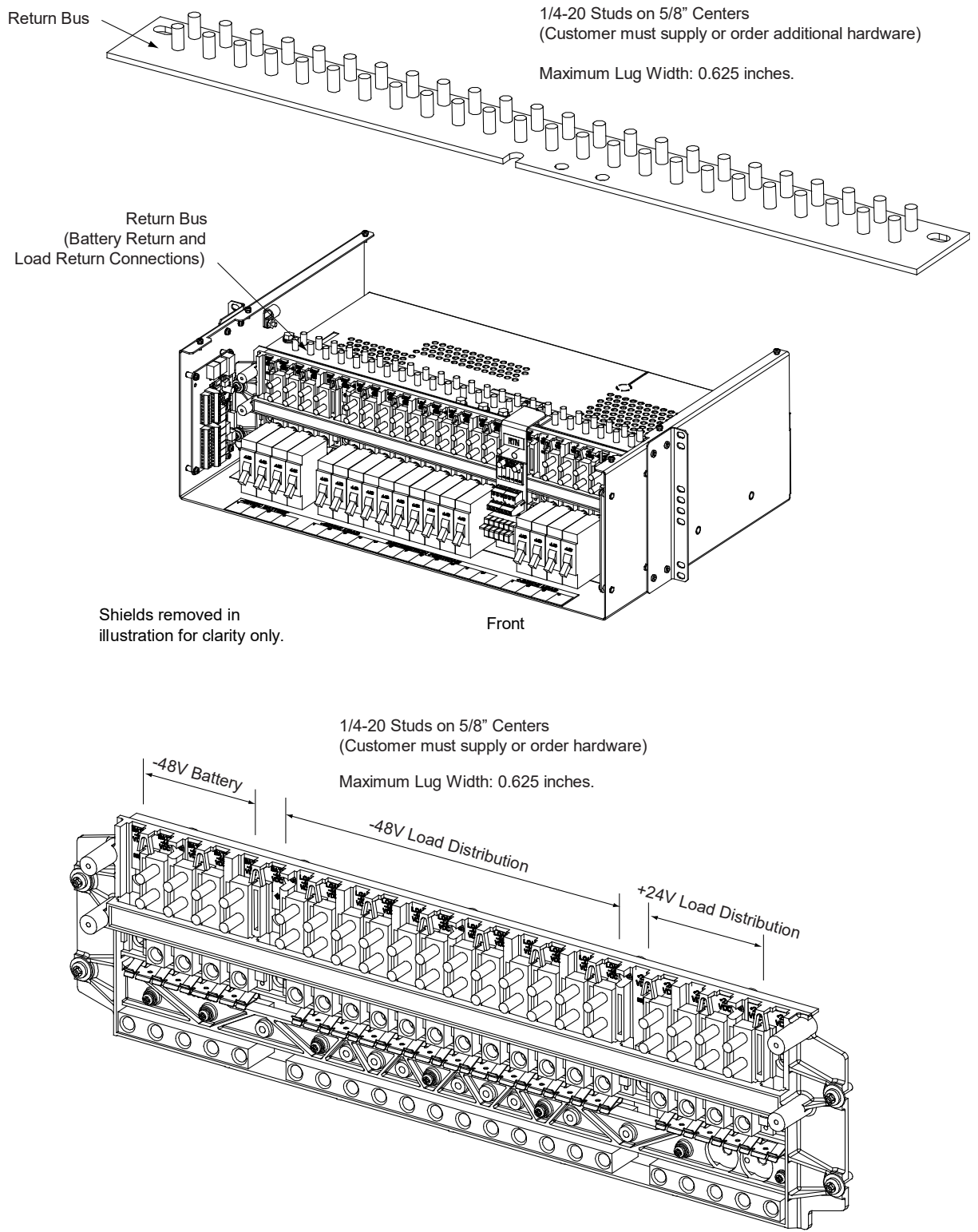

Figure 7
Load and Load Return Connections, 582137000 List 7 Distribution Cabinet

Vertiv™ NetSure™ 512NGBB DC Power System

System Application Guide

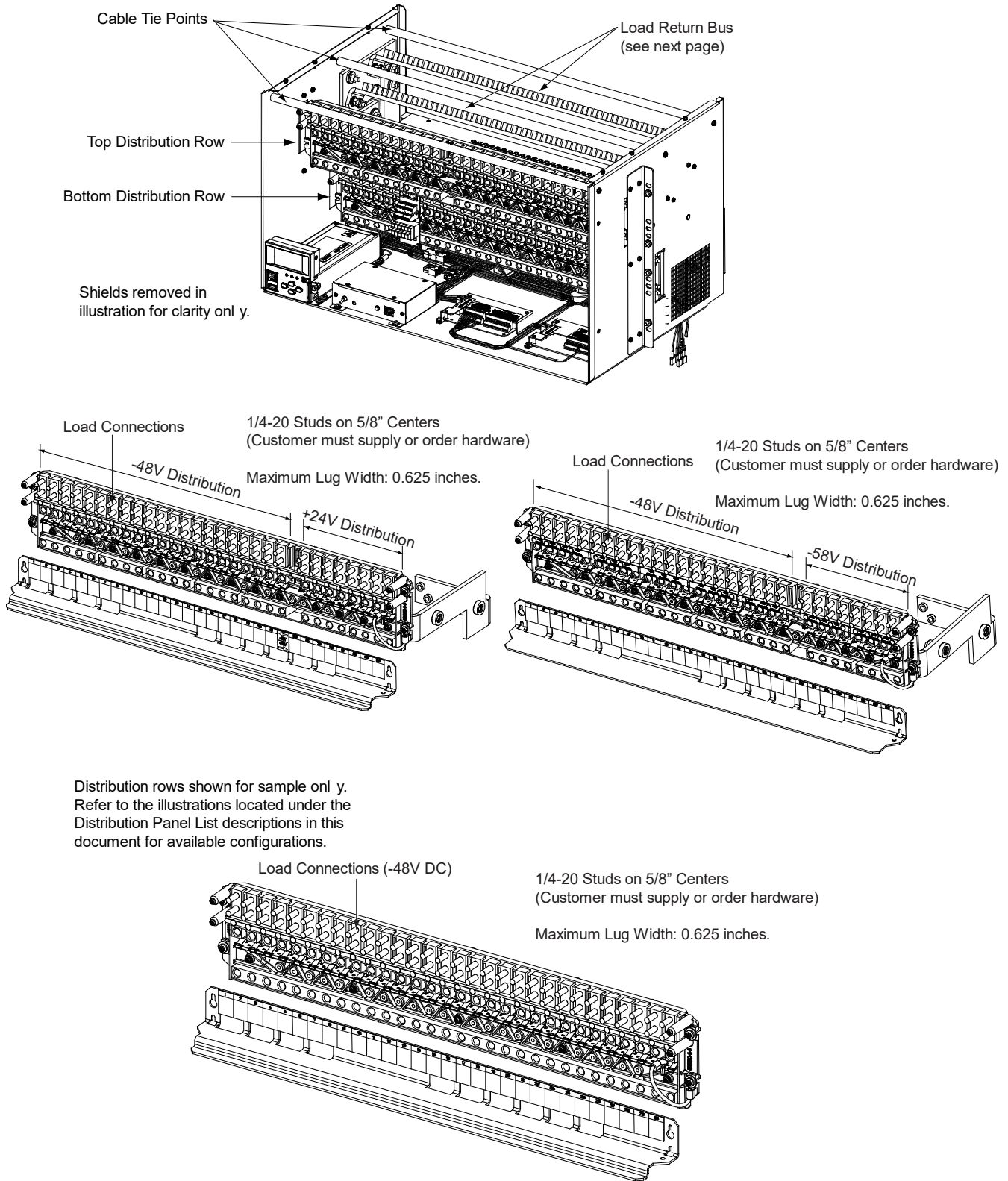

Figure 8
Load Side Connections, 582137000 List 27 Distribution Cabinet

Vertiv™ NetSure™ 512NGBB DC Power System

System Application Guide

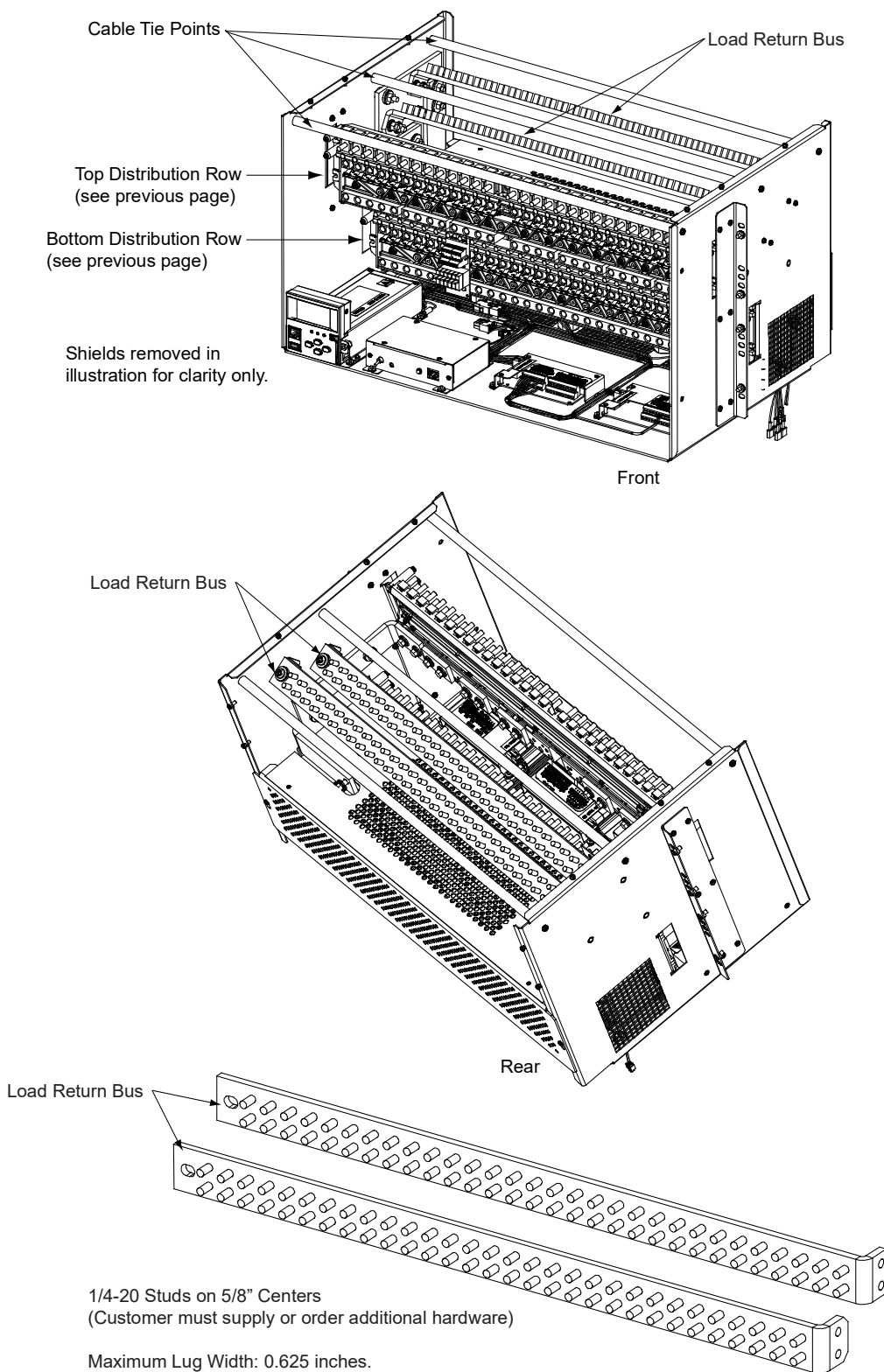

Figure 9
Load Return Side Connections, 582137000 List 27 Distribution Cabinet

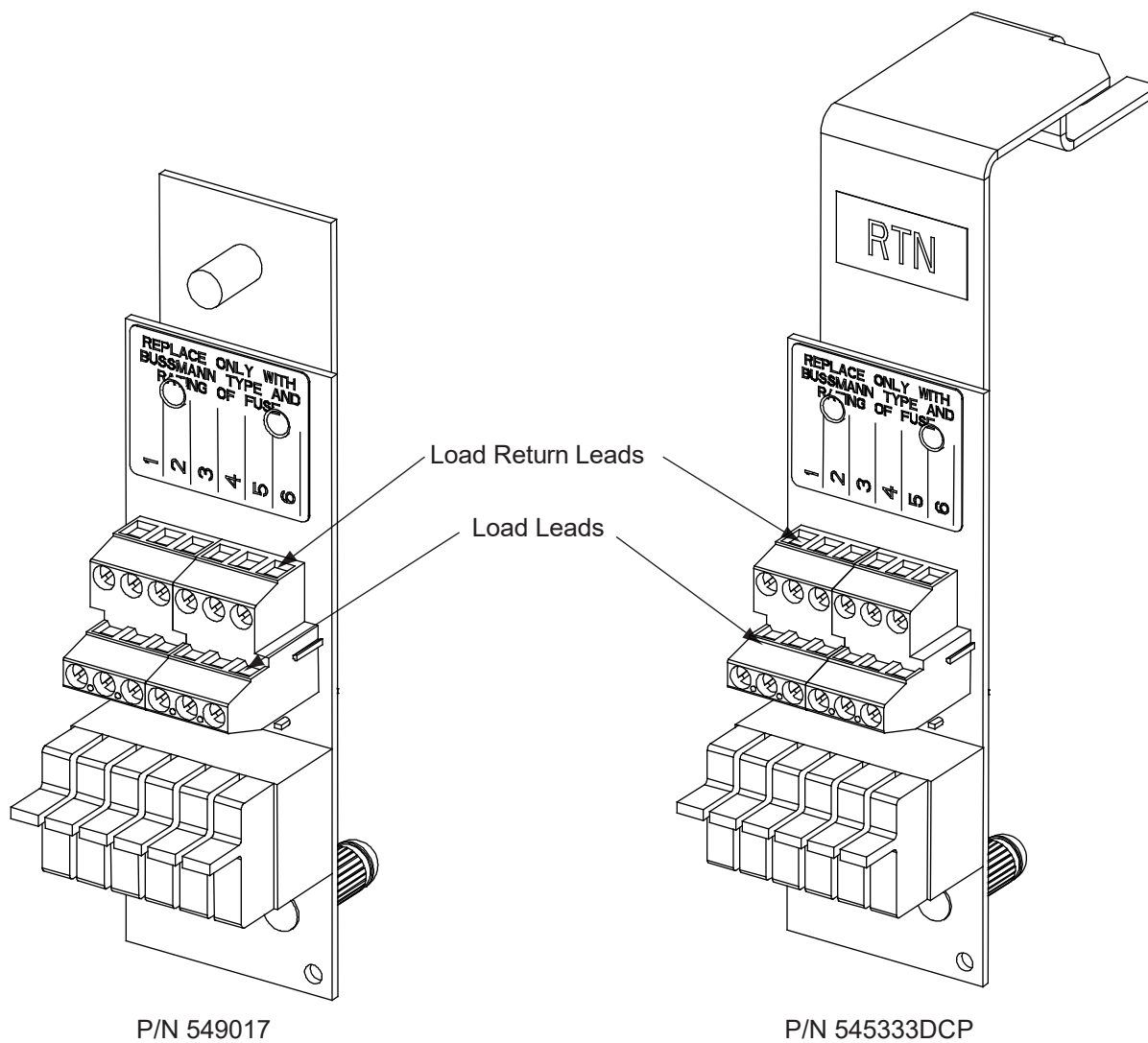

Figure 10
Load Connections to GMT Fuse Block

Input Battery Connections

582137000 List 7 Distribution Cabinet

Input battery leads are connected to the individual battery busbars located on the distribution panel. Battery return leads are connected to the return busbar located at the top of the distribution cabinet. These busbars provide 1/4-20 studs for installation of customer-provided two-hole lugs that have 5/8 inch centers and 1/4 inch bolt clearance holes. Customer must provide (or order) lug mounting hardware.

Maximum size of wire to be connected to a single fuseholder/circuit breaker position is 2 AWG. Refer to Table 5 for available lugs. For wiring up to 350 kcmil, see “Special Application Crimp Lug / Strap Combination” in Table 7. Refer also to “Busbar Adapter and Hardware Kits” in Table 8 for other lug options. Lugs should be crimped per lug manufacturer’s specifications.

The rating of the distribution device determines the battery lead wire size requirement. Table 11 can be used to select recommended battery wire sizes and lugs for various loop lengths per fuse/circuit breaker ampere rating.

Refer to Figure 11.

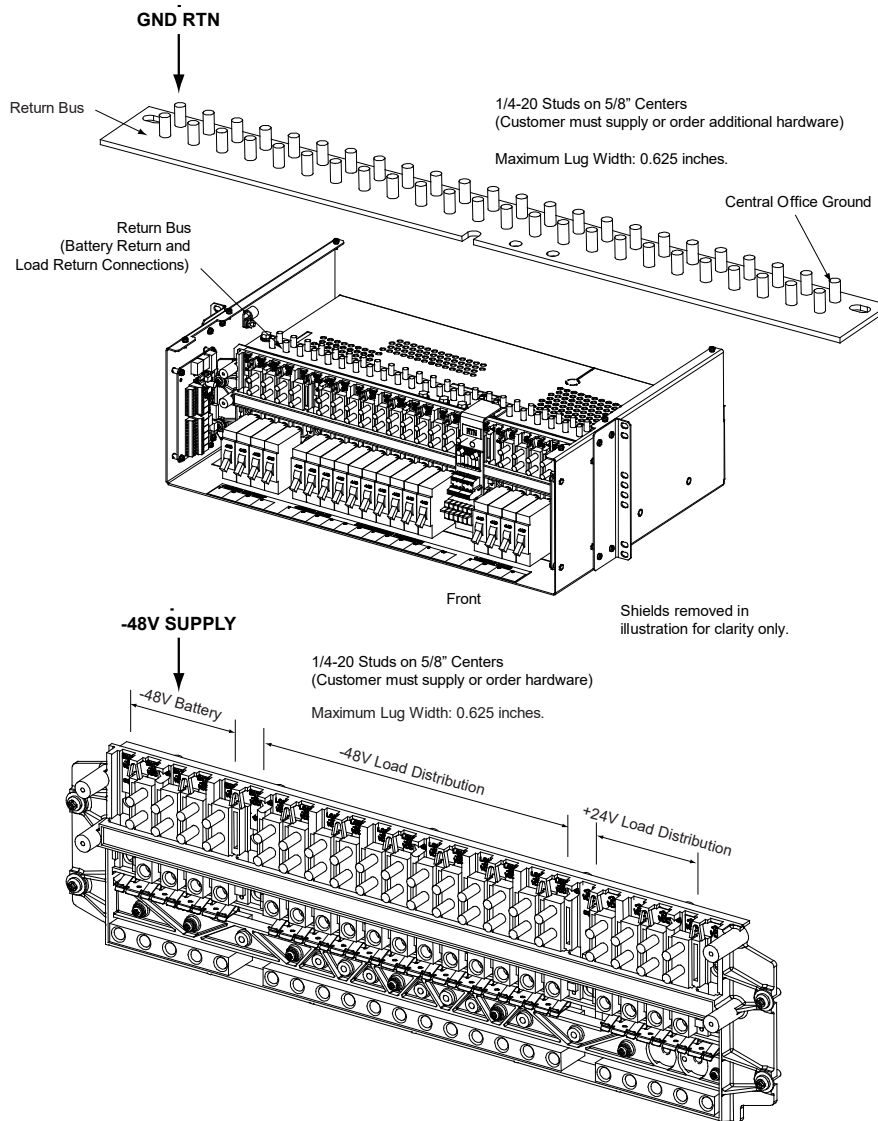

Figure 11
Battery and Central Office Ground Connections, 582137000 List 7 Distribution Cabinet

Vertiv™ NetSure™ 512NGBB DC Power System

System Application Guide

582137000 List 27 Distribution Cabinet

Input battery leads are connected to the battery busbar and battery return busbar. These busbars provide 3/8-16 studs for installation of customer-provided two hole lugs that have 1 inch centers and 3/8 inch bolt clearance holes. Customer must provide lug mounting hardware.

Battery wire size and lug requirements are determined by site requirements. See Table 6 for available lugs. Lugs should be crimped per lug manufacturer's specifications.

Refer to Figure 12.

BATTERY AND BATTERY RETURN CONNECTIONS

3/8-16 Studs on 1" Centers
(Customer must supply additional hardware)

Maximum Lug Width: 1.88 inches.

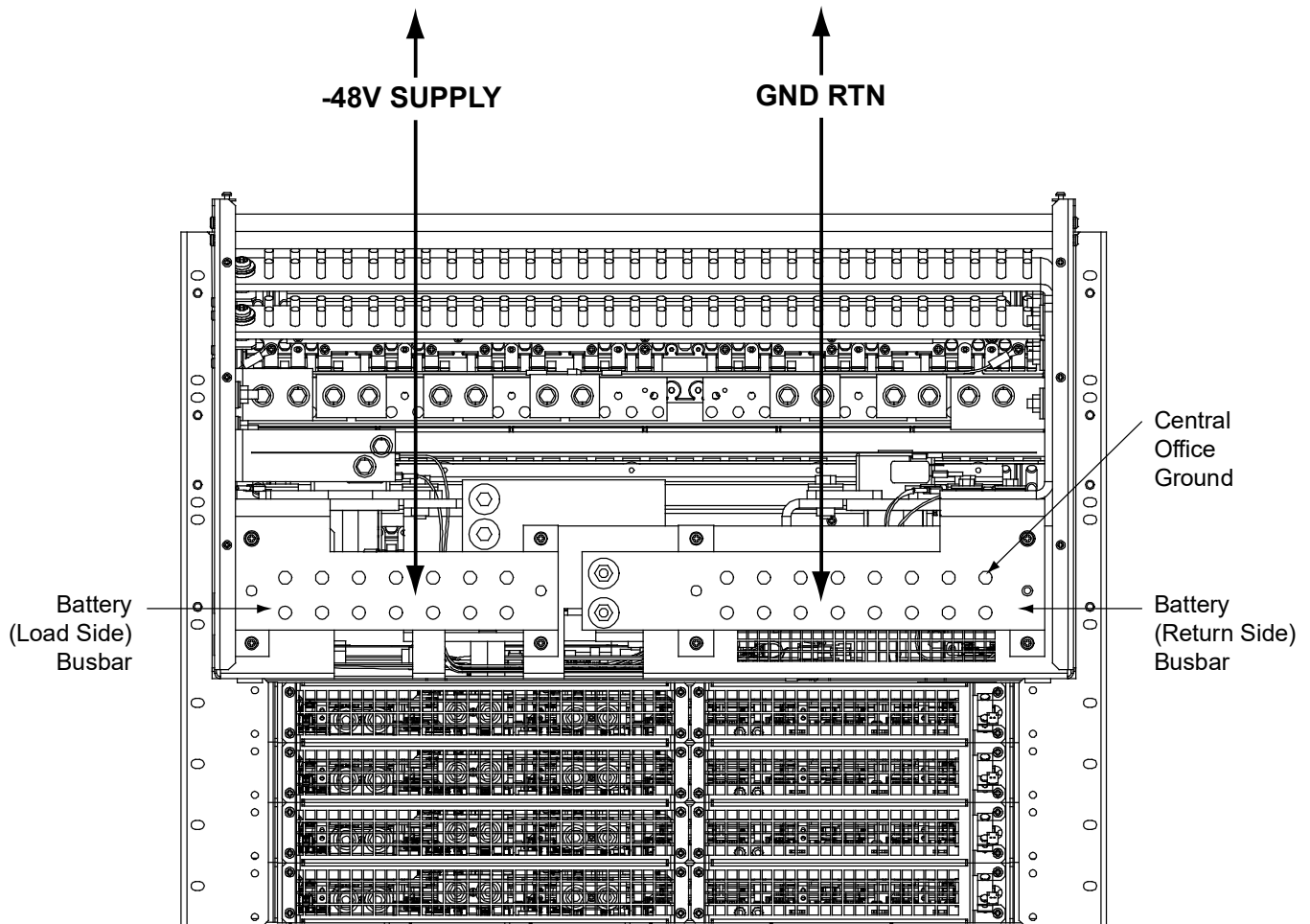

Rear View (rear cover shields removed)

Figure 12
Battery and Central Office Ground Connections, 582137000 List 27 Distribution Cabinet

SPECIFICATIONS

1. SYSTEM

1.1 DC Output Ratings

1.1.1 See page 3.

1.2 AC Input Ratings

1.2.1 See page 3.

1.3 Environmental Ratings

1.3.1 Operating Ambient Temperature Range:

(A) System with List 7 Distribution Cabinet: -40°C to +65°C (-40°F to +149°F).

(B) System with List 27 Distribution Cabinet:

(1) -40°C to +65°C (-40°F to +149°F), 525A / -48VDC and 400A / +24VDC or 300A, maximum / -58VDC, maximum.

(2) Non-Vertiv cabinet system:

Power system tested in 65°C ambient without airflow

400A / -48 VDC and 300A (max.) / -58 VDC (max.)

(300A per row for both -48 VDC and -58 VDC).

1.3.2 Storage Ambient Temperature Range: -40°C to +85°C (-40°F to +185°F).

1.3.3 Humidity: This Power System is capable of operating in an ambient relative humidity range of 0% to 95%, non-condensing.

1.3.4 Altitude: Capable of operating in an altitude range of -200 feet to 10,000 feet. The maximum operating ambient temperature should be de-rated by 3°C per 1000 feet above 6562 feet.

1.3.5 Ventilation Requirements: The system must be mounted so ventilating openings are not blocked and temperature of the air entering the system does not exceed the Operating Ambient Temperature Range stated above. Refer also to "Mounting" below.

1.3.6 Mounting: Refer to "Overall Dimensions" on page 66 for mounting dimensions.

- This product is intended only for installation in a restricted access location on or above a non-combustible surface.
- This product must be located in a controlled environment with access to crafts persons only.
- This product is intended for installation in network telecommunication facilities (CO, vault, hut, or other environmentally controlled electronic equipment enclosure).
- This product is intended to be connected to the common bonding network in a network telecommunication facility (CO, vault, hut, or other environmentally controlled electronic equipment enclosure).
- The DC return connection to this system can remain isolated from system frame and chassis (DC-I).
- This system is suitable for installation as part of the Common Bonding Network (CBN).
- Rectifier, converter, and mounting shelf ventilating openings must not be blocked and temperature of air entering rectifiers and converters must not exceed the rated operating ambient temperature range.
- Clearance requirements are:

The distance from the rear of the system to a wall or other solid structure must not be less than four (4) inches. This will assure proper airflow through the rectifier and converter modules.

Note: Minimum spacing specified for ventilation may not permit replacement of certain components such as busbars or module mounting shelves.

Vertiv™ NetSure™ 512NGBB DC Power System

System Application Guide

1.4 Compliance Information

1.4.1 Safety Compliance: This panel is UL Recognized for use in DC Power Distribution Centers for Communications Equipment.

1.4.2 NEBS Compliance (Pending List 7): Compliance verified by a Nationally Recognized Testing Laboratory (NRTL) per GR-1089-CORE and GR-63-CORE. Contact Vertiv for NEBS compliance reports.

Rectifier Modules: In order to remain compliant during a fan failure condition, the backup battery connection must be utilized to provide sufficient power to the loads for up to eight (8) hours when the system is operated at greater than 50% output power. If no backup battery connection is used, the system must operate with a redundant module installed.

Converter Modules: In order to remain compliant during a fan failure condition, the system must operate with a redundant module installed.

1.5 IB2 and EIB (Controller Interface Board) Ratings

1.5.1 Digital Input Ratings

(A) Maximum Voltage Rating: 60 VDC.

(B) Active High: > 19 VDC.

(C) Active Low: < 1 VDC.

1.5.2 Relay Ratings

(A) Steady State: 0.5 A @ 60 VDC; 1.0 A @ 30 VDC.

(B) Peak: 3 A @ 30 VDC.

2. MODULE MOUNTING SHELF

Refer to PD588705300.

3. RECTIFIER

Refer to the Rectifier Instructions (UM1R482000E3).

4. -48 VDC TO +24 VDC CONVERTER

Refer to the Converter Instructions (UM1C48241500).

5. -48 VDC TO -58 VDC CONVERTER

Refer to the Converter Instructions (UM1C48582000P3).

6. CONTROLLER

Refer to the Controller Instructions (UM1M830BNA).

For controller factory settings, refer to the Controller Configuration Drawing (C-drawing).

MECHANICAL SPECIFICATIONS

Overall Dimensions

Refer to PD588705300 for additional module mounting shelf dimensions.

Systems with List 7 Distribution Cabinet

1. All dimensions are in inches unless otherwise specified.
2. Finish:
 Distribution Cabinet: Plated Steel
 Module Mounting Shelf and Module Bodies: Bright Zinc Plating
 Module Faceplates: Textured Gray

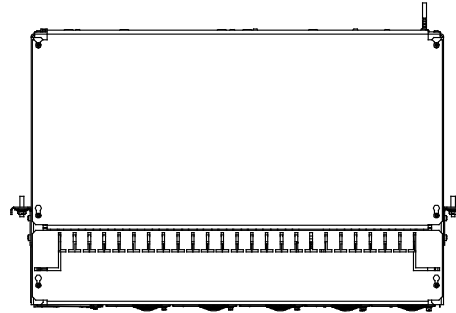

Top View

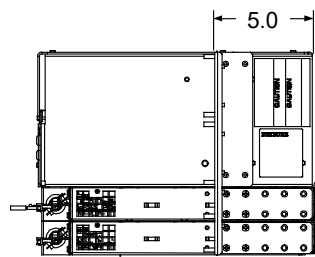

Left Side View

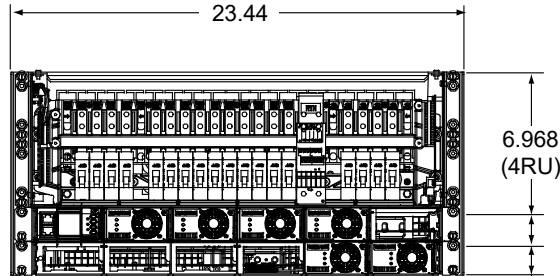

Front View

See Mounting Angle Detail

1.72 (1RU) each

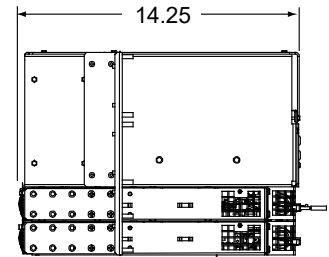

Right Side View

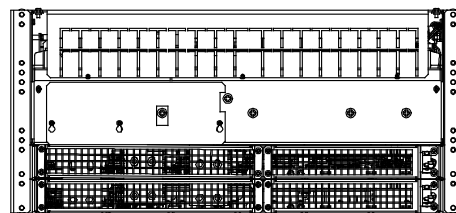

Rear View

Mounting Angle Detail

1. All dimensions are in inches unless otherwise specified.

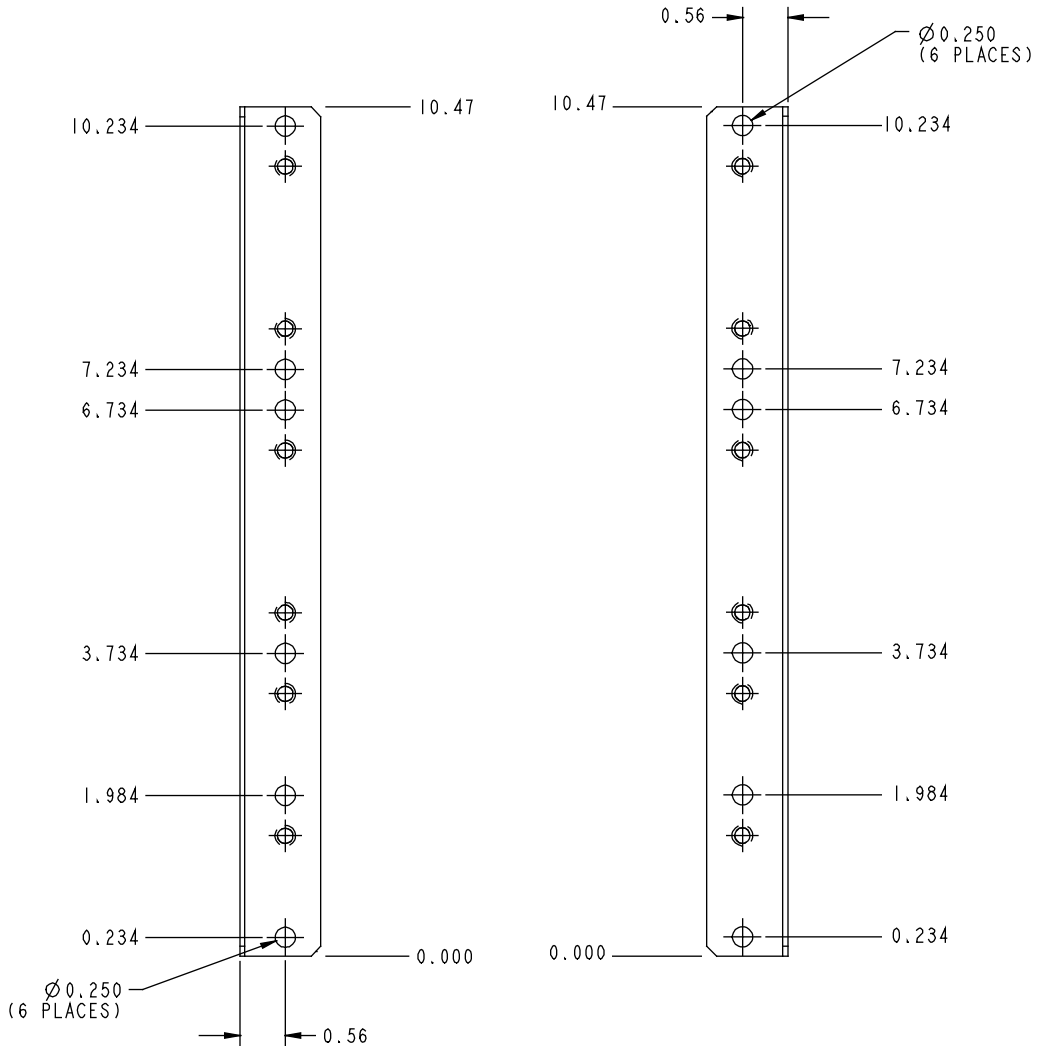

Vertiv™ NetSure™ 512NGBB DC Power System

System Application Guide

Systems with List 27 Distribution Cabinet

1. All dimensions are in inches unless otherwise specified.
2. Finish:
 - Distribution Cabinet: Plated Steel
 - Module Mounting Shelf and Module Bodies: Bright Zinc Plating
 - Module Faceplates: Textured Gray

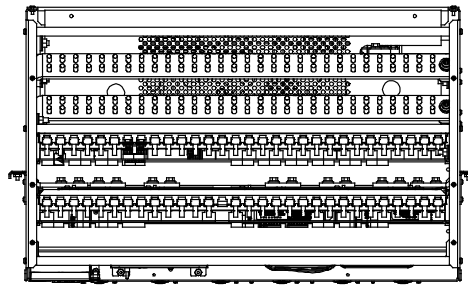

Top View

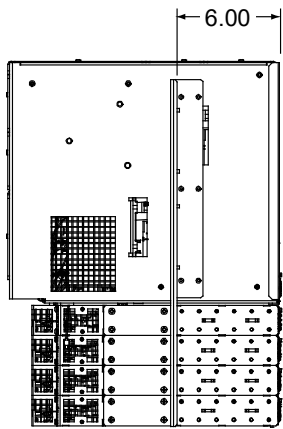

Left Side View

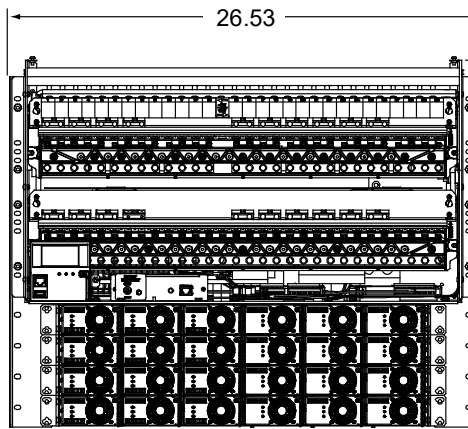

Front View

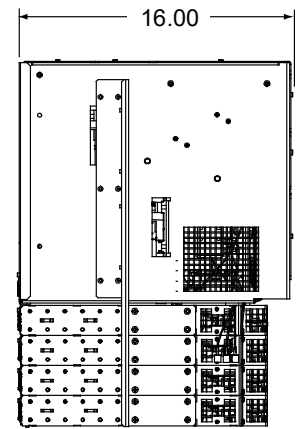

Right Side View

13.82
(8RU)

1.72
(1RU)
each

See Mounting Angle Detail

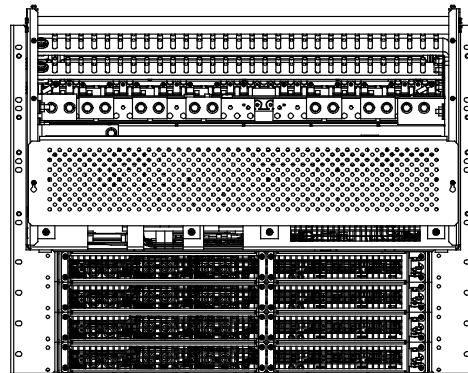

Rear View

Mounting Angle Detail

1. All dimensions are in inches unless otherwise specified.

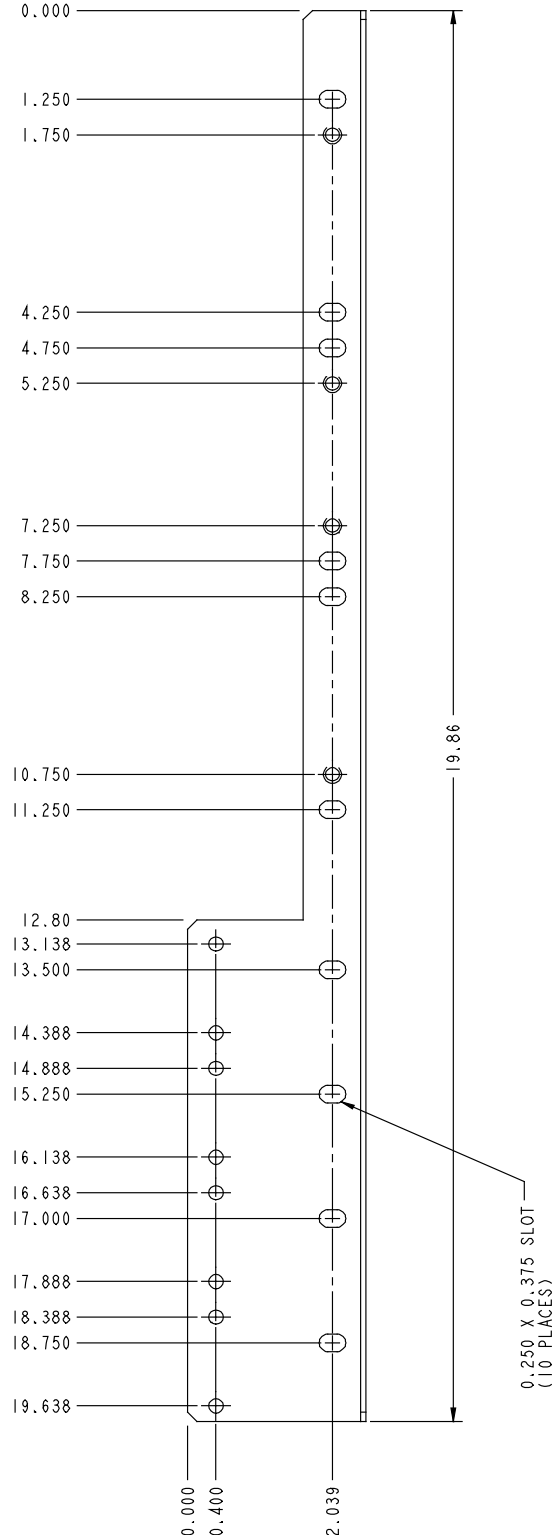
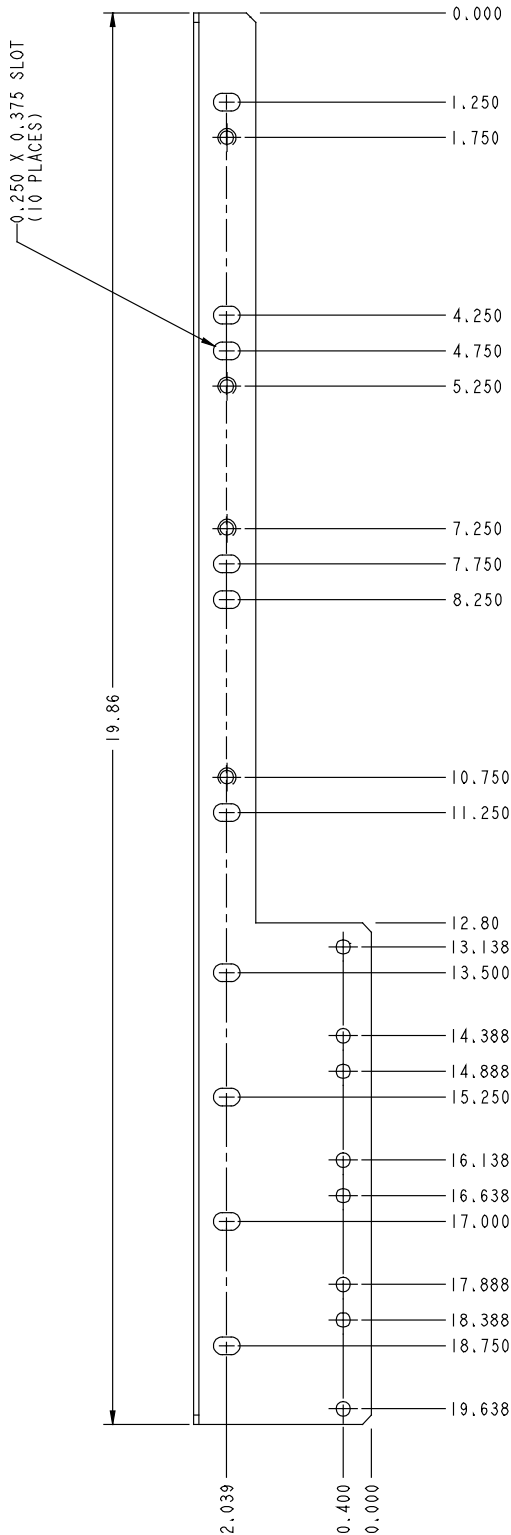

Vertiv™ NetSure™ 512NGBB DC Power System
System Application Guide

Weights

List Number or Part Number	Net Weight (lbs), each	Description
Distribution Cabinet		
58213700007	42	Distribution Cabinet, 1 Row
58213700027	52	Distribution Cabinet, 2 Rows
Rectifier / Converter Shelf		
58870530003	11.7	Rectifier / Converter Shelf
58870530012	10.1	Rectifier Shelf
1R482000E3	2.5	Rectifier Module
1C48241500	2.3	Converter Module
1C48582000P3	2.3	Converter Module
1M820BNA	2.2	ACU+ Controller
1M830BNA	2.2	NCU Controller
Distribution Panel, Primary Voltage		
582137000AC	8	Distribution Panel
Distribution Panel, Primary and Secondary Voltage Plus Battery Disconnect		
582137000BW	8	Distribution Panel
Distribution Panel, Dual Voltage		
582137000DH	8	Distribution Panel
582137000DI	8	Distribution Panel
582137000DJ	8	Distribution Panel
582137000DK	8	Distribution Panel
582137000DL	8	Distribution Panel
582137000FG	8	Distribution Panel
582137000FH	8	Distribution Panel
582137000FI	8	Distribution Panel
582137000FJ	8	Distribution Panel
582137000FK	8	Distribution Panel
582137000FL	8	Distribution Panel
582137000FM	8	Distribution Panel
582137000GC	8	Distribution Panel
Battery Disconnect Contactor		
582137000CA	7	600 Amp Battery Disconnect Contactor
Low Voltage Disconnect		
582137000LB	1	Low Voltage Battery Disconnect Option
582137000LL	2.5	Low Voltage Load Disconnect Option
Manual Battery Disconnect		
582137000MB	1	Manual Battery Disconnect Option
Distribution Elements		
549017	1.5	Kit, 6-Position GMT Fuse Module
545333DCP	1.5	Kit, 6-Position GMT Fuse Module

Vertiv™ NetSure™ 512NGBB DC Power System

System Application Guide

RELATED DOCUMENTATION

System Quick Start Guide:	QS582137000
System Installation Instructions:	IM582137000
System User Instructions:	UM582137000
NCU Controller User Instructions:	UM1M830BNA
Rectifier Instructions:	UM1R482000E3
Converter Instructions:	UM1C48241500
Converter Instructions:	UM1C48582000P3
Retrofit Kit Instructions:	IM60028248
Module Mounting Shelf Power Data Sheet:	PD588705300
Main Schematic Diagrams:	SD582137000 (System) SD588705300 (Module Mounting Shelf)
Main Wiring Diagrams:	T582137000 (System) T588705300 (Module Mounting Shelf)

Vertiv.com | Vertiv Headquarters, 505 N Cleveland Ave, Westerville, OH 43082, USA

© 2023 Vertiv Group Corp. All rights reserved. Vertiv™ and the Vertiv logo are trademarks or registered trademarks of Vertiv Group Corp. All other names and logos referred to are trade names, trademarks or registered trademarks of their respective owners. While every precaution has been taken to ensure accuracy and completeness here, Vertiv Group Corp. assumes no responsibility, and disclaims all liability, for damages resulting from use of this information or for any errors or omissions.

